

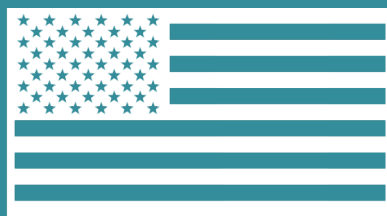

**COMMERCIAL FURNITURE  
USA  
OUTDOOR + INDOOR**

**QUICKSHIP  
2026**



[WWW.BUMOUTDOOR.COM](http://WWW.BUMOUTDOOR.COM)

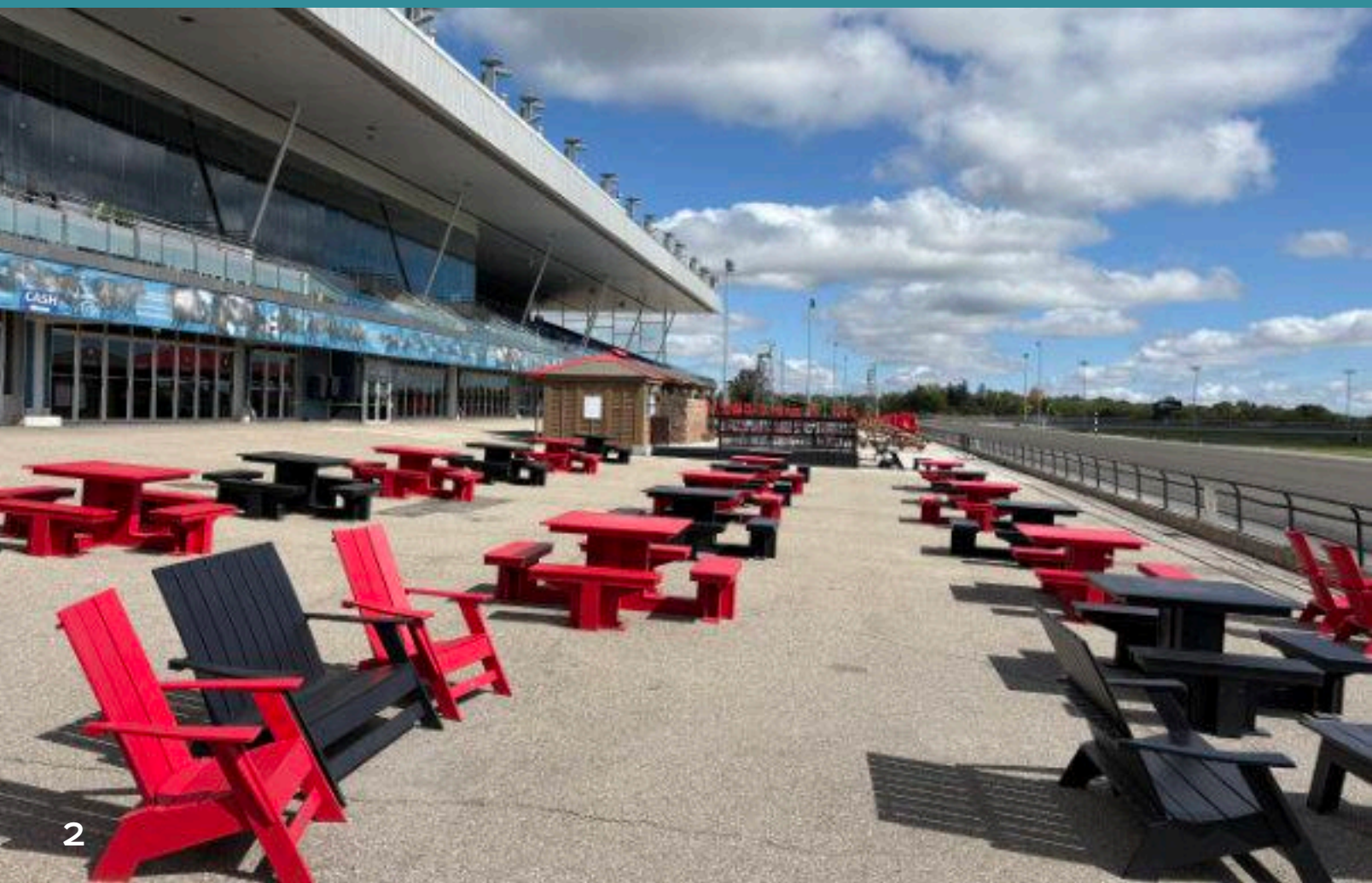





**NORTH  
AMERICA'S  
LARGEST  
SUPPLIER OF  
COMMERCIAL  
PATIO FURNITURE  
FOR:**

**RESTAURANTS**

**HOTELS**

**CONDO TERRACES**

**GOLF COURSES**

**PRIVATE CLUBS**

**EDUCATIONAL SETTINGS**

**OUTDOOR MEETING SPACES**

**AMUSEMENT PARKS**

**MUNICIPAL PARKS**

**CORPORATE OUTDOOR SPACES**

**RETIREMENT RESIDENCE PATIOS**

**RESIDENTIAL PATIOS**



**COMMERCIAL FURNITURE**  
**USA**  
OUTDOOR + INDOOR

## **QUICKSHIP 2026 TABLE OF CONTENTS**

ICON LEGEND.....	6
ARMCHAIRS .....	8
SIDE CHAIRS .....	31
BAR STOOLS.....	55
TABLES: DINING HEIGHT.....	80
TABLES: BAR HEIGHT .....	102
TABLETOPS.....	111
DINING BASES .....	120
BAR BASES.....	127
LOUNGE SEATING .....	133
LOUNGE CUSHIONS.....	142
LOUNGE TABLES.....	165
COMPLEMENTS.....	177
SHADE .....	190
PLANTERS .....	206
FLAME .....	217
TERMS & CONDITIONS .....	225



Our chairs are tested & rated to hold 300 lbs



# QUICKSHIP 2026

## ICON LEGEND



Special Order Colors  
Expect 12-16 Weeks for delivery



Specially Treated for High Salinity  
Environments



Non Slip Replaceable Feet



Stackable



Nesting



Remote Control Included



Umbrella Hole



Assembly Required



Adjustable Feet



Resistant to extreme outdoor temperatures



Wheels available



ADA Compliant



# ARMCHAIRS





**NARDI**  
YOUR OUTDOOR LIVING  
MADE IN ITALY

**Bora**

Uniformly colored polypropylene & fiberglass • UV Protected  
See cushions Page 28

**LIST: \$170 EA.    SELL: \$110 EA.**

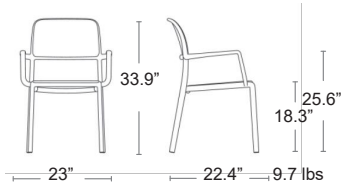

-  BIANCO  
40242.00
-  ANTRACITE  
40242.02
-  ROSSO  
40242.07
-  TORTORA  
40242.10
-  AGAVE  
40242.16







Riva

Uniformly colored polypropylene & fiberglass • UV Protected  
See cushions Page 28

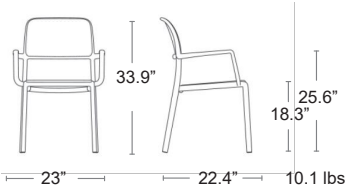

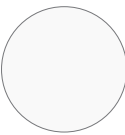
**LIST: \$170 EA.    SELL: \$110 EA.**



-  BIANCO  
40246.00
-  ANTRACITE  
40246.02
-  ROSSO  
40246.07
-  TORTORA  
40246.10
-  AGAVE  
40246.16



**NARDI**  
YOUR OUTDOOR LIVING  
MADE IN ITALY



## Costa

Uniformly colored polypropylene & fiberglass • UV Protected  
See cushions Page 28

**LIST: \$170 EA.    SELL: \$110 EA.**

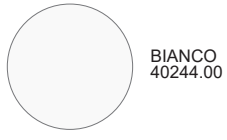
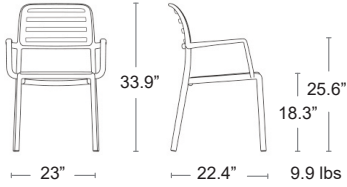

BIANCO  
40244.00



ANTRACITE  
40244.02



ROSSO  
40244.07

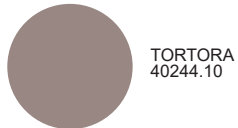

TORTORA  
40244.10

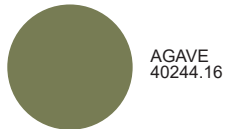

AGAVE  
40244.16



**NARDI**  
YOUR OUTDOOR LIVING  
MADE IN ITALY



## Cassia

Uniformly colored polypropylene & fiberglass • UV Protected  
See cushions Page 28

LIST: \$190 EA.    SELL: **\$125 EA.**

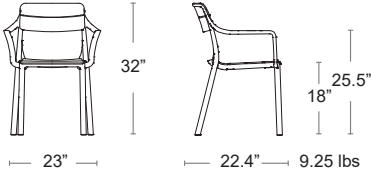

ANTRACITE  
40220.02

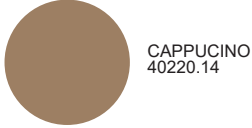

CAPPUCINO  
40220.14



CORDA  
40220.24



BASALTO  
40220.25

regeneration

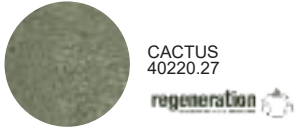

CACTUS  
40220.27

regeneration



BORGOGNA  
40220.38

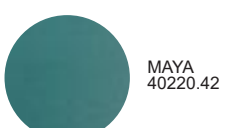

MAYA  
40220.42



TABACCO  
40220.53

**NARDI**  
YOUR OUTDOOR LIVING  
MADE IN ITALY

Trill

Uniformly colored polypropylene & fiberglass • UV Protected  
See cushions Page 28

LIST: \$190 EA.     **SELL: \$125 EA.**

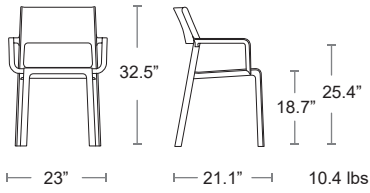

-  BIANCO  
40250.00
-  ANTRACITE  
40250.02
-  GRIGIO  
40250.03
-  TORTORA  
40250.10
-  AGAVE  
40250.16
-  OTTANIO  
40250.49
-  SENAPE  
40250.56
-  TABACCO  
40250.53







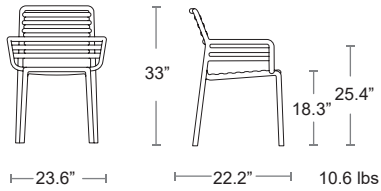

## Doga

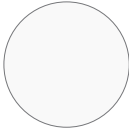
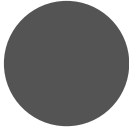
Uniformly colored polypropylene & fiberglass • UV Protected  
See cushions Page 28

**LIST: \$190 EA.    SELL: \$125 EA.**



-  BIANCO  
40254.00
-  ANTRACITE  
40254.02
-  CAPPUCINO  
40254.14
-  MENTA  
40254.15
-  AGAVE  
40254.16
-  PERA  
40254.18
-  MARSALA  
40254.21
-  TABACCO  
40254.53



**NARDI**  
YOUR OUTDOOR LIVING  
MADE IN ITALY

## Tiberina

Uniformly colored polypropylene & fiberglass • UV Protected  
See cushions Page 28



LIST: \$190 EA.

SELL: **\$125 EA.**

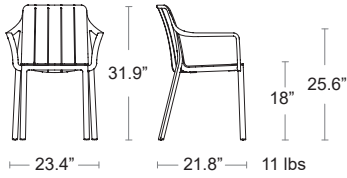

ANTRACITE  
40205.02

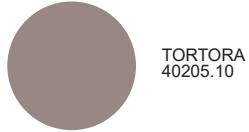

TORTORA  
40205.10

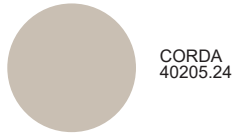

CORDA  
40205.24



TERRA  
40205.44

regeneration



**NARDI**  
YOUR OUTDOOR LIVING  
MADE IN ITALY



## Net

Uniformly colored polypropylene & fiberglass • UV Protected  
See cushions Page 28

**LIST: \$200 EA.    SELL: \$130 EA.**

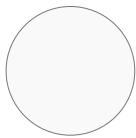
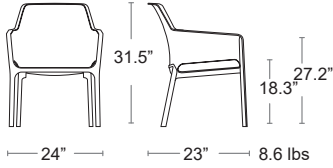

BIANCO  
40326.00

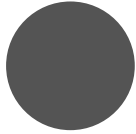

ANTRACITE  
40326.02



SALICE  
40326.04



TORTORA  
40326.10



SENAPE  
40326.56



CORALLO  
40326.75



## Marco Wicker

Square tubular aluminum frame • E-Plated Powder Coat finish • Viro Wicker Seat & Back • Polywood armrests

**LIST: \$270 EA.    SELL: \$175 EA.**

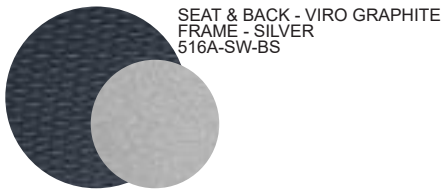
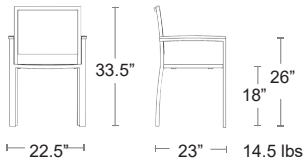

SEAT & BACK - VIRO GRAPHITE  
FRAME - SILVER  
516A-SW-BS

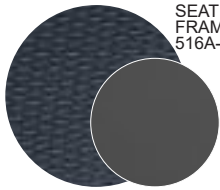

SEAT & BACK - VIRO GRAPHITE  
FRAME - ANTRACITE  
516A-SW-BA





## Marco Sling

Square tubular aluminum frame • E-Plated Powder Coat finish •  
Batyline Seat & Back • Polywood armrests

**LIST: \$270 EA.    SELL: \$175 EA.**

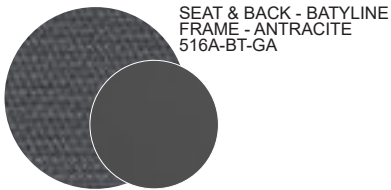
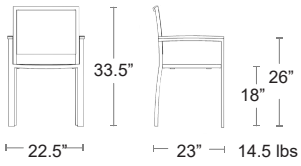



## Marco Polywood

Square tubular aluminum frame • E-Plated Powder Coat finish • Polywood Seat, Back & Armrests

**LIST: \$270 EA.    SELL: \$175 EA.**

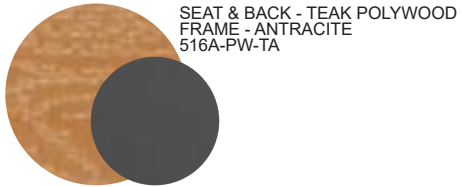
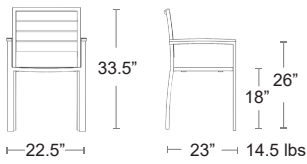

SEAT & BACK - TEAK POLYWOOD  
FRAME - ANTRACITE  
516A-PW-TA

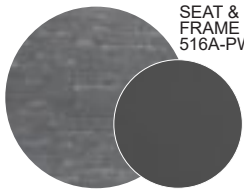

SEAT & BACK - GREY POLYWOOD  
FRAME - ANTRACITE  
516A-PW-GA

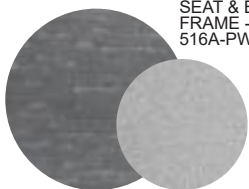

SEAT & BACK - GREY POLYWOOD  
FRAME - SILVER  
516A-PW-GS

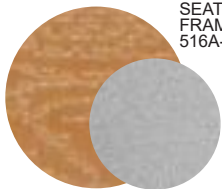

SEAT & BACK - TEAK POLYWOOD  
FRAME - SILVER  
516A-PW-TS





## Island Faux Wood

Faux Wood seat & back • Aluminum powder coated frame



LIST: \$320 EA.    SELL: \$210 EA.

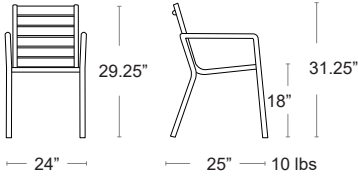

FAUX WOOD GREY  
FRAME - BLACK  
ISLAND-A-BLK-FWG



FAUX WOOD TEAK  
FRAME - SAND  
ISLAND-A-SND-FWT





# Island Sling

Batyline seat & back • Aluminum powder coated frame

LIST: \$370 EA.    **SELL: \$240 EA.**

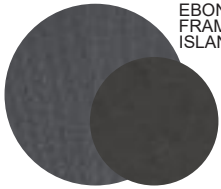
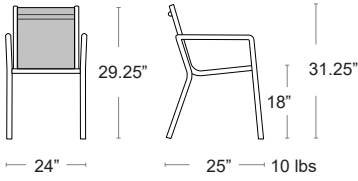

EBONY BATYLINE SLING  
FRAME - BLACK  
ISLAND-A-BLK-EBO

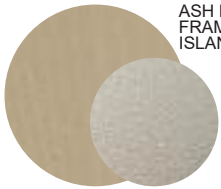

ASH BATYLINE SLING  
FRAME - SAND  
ISLAND-A-SND-ASH





## Capri Bucket

All-Weather Rope back & arms • Round tubular aluminum frame • E-Plated Powder Coat finish • Textaline seat cushion

LIST: \$360 EA.    SELL: **\$235 EA.**

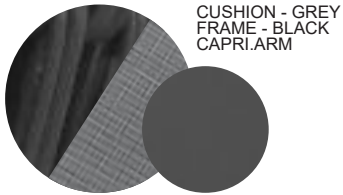
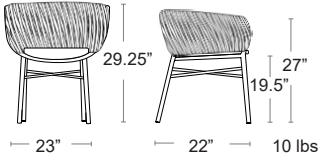







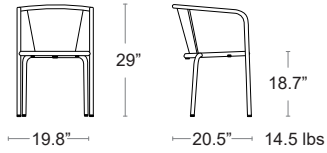

# Adico #508

Tubular steel frame • Solid steel seat & back • E-Plated Powder Coat finish

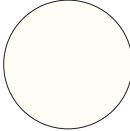

**LIST: \$390 EA.    SELL: \$255 EA.**

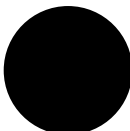

-  **YELLOW**  
508-1002
-  **WHITE**  
508-1310
-  **ORANGE**  
508-2012
-  **RED**  
508-3169
-  **GREEN**  
508-6021
-  **BLUE**  
508-6034
-  **BLACK**  
508-9005





## Sanibel

Welded Aluminum Frame • Quick Dry Foam seat & back •  
Pfifer Sling • E-Plated Powder Coat finish

**LIST: \$390 EA.    SELL: \$255 EA.**

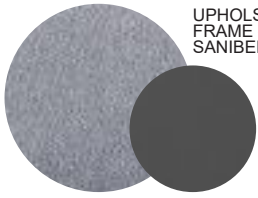
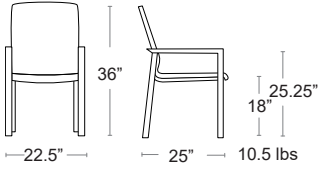

UPHOLSTERY - PFIFER SLING CHARCOAL  
FRAME - ANTRACITE  
SANIBEL-320



# HOUE

MADE IN DENMARK



## RECLIPS

Resin slats made from 97% recycled polypropylene • UV protected • Round tubular aluminum frame • E-Plated Powder Coat finish

LIST: \$450 EA.    **SELL: \$295 EA.**

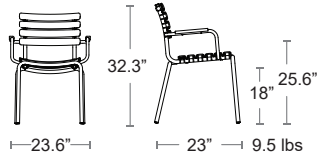

-  SKY BLUE  
22302-14
-  BLACK  
22302-24
-  DARK GREY  
22302-26
-  OLIVE GREEN  
22302-27



BAMBOO ARMS available  
FOR ALL COLORS  
BAMBOO-ARM-REST-03

LIST: \$8 PAIR

SELL: **\$5 PAIR**



## Aria Armchair With Cushions

Uniformly colored polypropylene & fiberglass • UV Protected

**SEAT & BACK CUSHIONS INCLUDED**

**CHOOSE A FRAME COLOR & A CUSHION FABRIC FROM THE IN STOCK SELECTIONS PAGE 28**

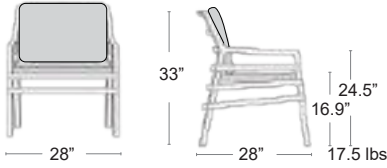

**LIST: \$600 EA.    SELL: \$390 EA.**

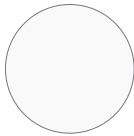

BIANCO  
203308000-  
BIANCO-FRAME



ANTRACITE  
203308002-  
ANT-FRAME



CAFFE  
203308005-  
CAFFE-FRAME



TORTORA  
203308010-  
TORT-FRAME





# Armchair Cushions



Sunbrella 100% Solution dyed acrylic • Zippered removable cover • Washable  
 Custom Sunbrella Colors available for a 25% Surcharge • Expect 3-4 weeks for delivery

**LIST: \$70 EA.    SELL: \$45 EA.**



SPECTRUM  
DAFFODIL  
-48024



SPECTRUM  
CILANTRO  
-48022



SPECTRUM  
EGGSHELL  
-48018



CANVAS  
GRANITE  
-5402



SPECTRUM  
CHERRY  
-48096



SPECTRUM  
CARBON  
-48085



CANVAS  
REGATTA  
-5493



CANVAS  
ARUBA  
-5416



CANVAS  
MELON  
-5415



PEYTON  
GRANITE  
-56075



DOLCE  
OASIS  
-56001



DOLCE  
MANGO  
-56000



CABANA  
CLASSIC  
-58030

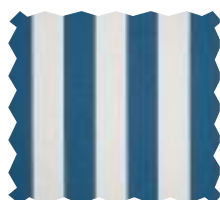

CABANA  
REGATTA  
-58029



MILANO  
CHAR  
-56079



Enhance patios, rooftops, & outdoor seating areas with custom commercial-grade cushions made with Sunbrella® performance fabric. Durable, professional seating solutions available for restaurants, hotels, resorts, offices & more.

-  Built for High Traffic • withstands daily use in busy commercial environments
-  UV-Protected & Fade-Resistant • maintains a polished, professional look, season after season
-  Weather-Resistant & Easy to Maintain • designed to handle spills, rain, & outdoor exposure
-  Custom Branding Options - wide range of fabrics, colors, & styles to align with your brand identity

Deliver comfort, style, and long-lasting quality to your guests, clients, & staff.

 For fabric samples, bulk pricing, & custom solutions contact: [samplerequest@bumoutdoor.ca](mailto:samplerequest@bumoutdoor.ca)







## SIDE CHAIRS



# Stack Mini Stool

Uniformly colored polypropylene & fiberglass • UV Protected



LIST: \$120 EA.    SELL: **\$80 EA.**

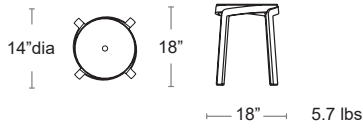

-  **BASALTO**  
40357.25
-  **CACTUS**  
40357.27
-  **GESSO**  
40357.29
-  **TERRA**  
40357.44



**PAPATYA**

MADE IN TURKEY

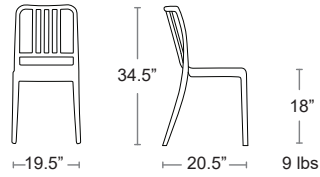

## Varia

Uniformly colored polypropylene & fiberglass • UV Protected  
See cushions, Page 52

**LIST: \$150 EA.    SELL: \$100 EA.**

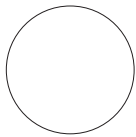

WHITE  
VARIA-01WHITE



RED  
VARIA-04RED



WARM GREY  
VARIA-17WARM GREY



ANTRACITE  
VARIA-22ANTRACITE



GREEN  
VARIA-54GREEN

**NARDI**  
YOUR OUTDOOR LIVING  
MADE IN ITALY



## Riva

Uniformly colored polypropylene & fiberglass • UV Protected  
See cushions, Page 52

**LIST: \$150 EA.    SELL: \$95 EA.**

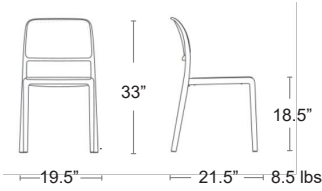

**NARDI**  
YOUR OUTDOOR LIVING  
MADE IN ITALY



## Bora

Uniformly colored polypropylene & fiberglass • UV Protected  
See cushions, Page 52

**LIST: \$150 EA.    SELL: \$95 EA.**

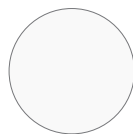
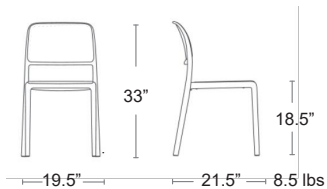

BIANCO  
40243.00

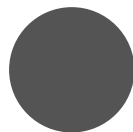

ANTRACITE  
40243.02



ROSSO  
40243.07



TORTORA  
40243.10

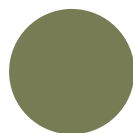

AGAVE  
40243.16



**NARDI**  
YOUR OUTDOOR LIVING  
MADE IN ITALY



## Costa

Uniformly colored polypropylene & fiberglass • UV Protected  
See cushions, Page 52

**LIST: \$150 EA.    SELL: \$95 EA.**

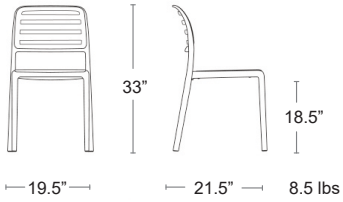

**NARDI**  
YOUR OUTDOOR LIVING  
MADE IN ITALY



### Cassia

Uniformly colored polypropylene & fiberglass • UV Protected  
See cushions, Page 52

**LIST: \$170 EA.     SELL: \$110 EA.**

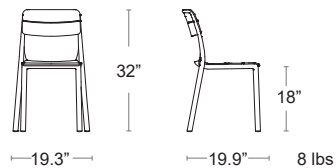

ANTRACITE  
40221.02



CAPPUCINO  
40221.14



CORDA  
40221.24

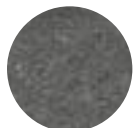

BASALTO  
40221.25

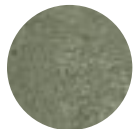

CACTUS  
40221.27



BORGOGNA  
40221.38



MAYA  
40221.42



TABACCO  
40221.53

**NARDI**  
YOUR OUTDOOR LIVING  
MADE IN ITALY



## Trill

Uniformly colored polypropylene & fiberglass • UV Protected  
See cushions, Page 52

**LIST: \$170 EA.    SELL: \$110 EA.**

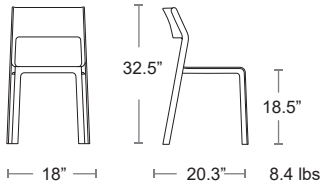

-  BIANCO  
40253.00
-  ANTRACITE  
40253.02
-  GRIGIO  
40253.03
-  TORTORA  
40253.10
-  AGAVE  
40253.16
-  OTTANIO  
40253.49
-  TABACCO  
40253.53
-  SENAPE  
40253.56



**NARDI**  
YOUR OUTDOOR LIVING  
MADE IN ITALY









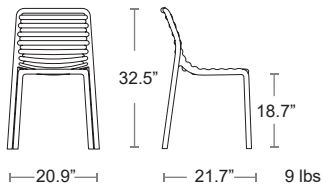

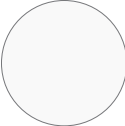
## Doga

Uniformly colored polypropylene & fiberglass • UV Protected  
See cushions, Page 52

**LIST: \$170 EA.    SELL: \$110 EA.**



-  BIANCO  
40255.00
-  ANTRACITE  
40255.02
-  CAPPUCINO  
40255.14
-  MENTA  
40255.15
-  AGAVE  
40255.16
-  PERA  
40255.18
-  MARSALA  
40255.21
-  TABACCO  
40255.53

**NARDI**  
YOUR OUTDOOR LIVING  
MADE IN ITALY



## Tiberina

Uniformly colored polypropylene & fiberglass • UV Protected  
See cushions, Page 52

LIST: \$170 EA.    SELL: **\$110 EA.**

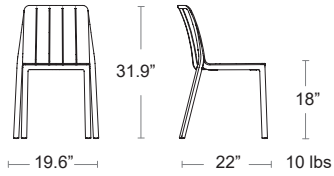

ANTRACITE  
40206.02



TORTORA  
40206.10



CORDA  
40206.24



TERRA  
40206.44

regeneration 



**NARDI**  
YOUR OUTDOOR LIVING  
MADE IN ITALY



## Bit

Uniformly colored polypropylene & fiberglass • UV Protected  
See cushions, Page 52

**LIST: \$170 EA.     SELL: \$110 EA.**

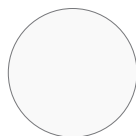
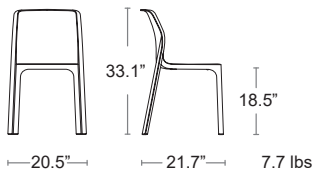

BIANCO  
40328.00

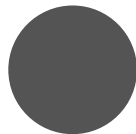

ANTRACITE  
40328.02



SALICE  
40328.04



TORTORA  
40328.10



SENAPE  
40328.56



CORALLO  
40328.75



## Parisian

Welded Aluminum frame • Wood-look finish • All-Weather wicker seat & back



**LIST: \$230 EA.    SELL: \$150 EA.**

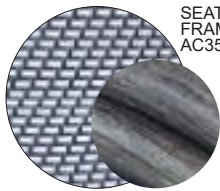
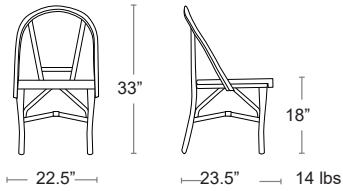

SEAT & BACK - BLACK & WHITE  
FRAME - TEAK  
AC3501N01RAT





## Marco Wicker

Square tubular aluminum frame • E-Plated Powder Coat finish  
• Viro Wicker Seat & Back

**LIST: \$270 EA.    SELL: \$175 EA.**

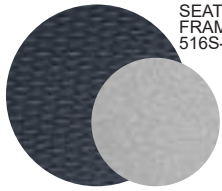
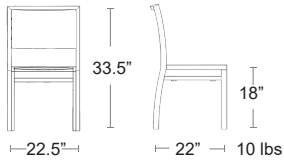

SEAT & BACK - VIRO GRAPHITE  
FRAME - SILVER  
516S-SW-BS

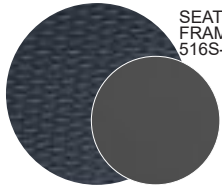

SEAT & BACK - VIRO GRAPHITE  
FRAME - ANTRACITE  
516S-SW-BA





## Marco Sling

Square tubular aluminum frame • E-Plated Powder Coat finish  
• Batyline Seat & Back

LIST: \$270 EA.

SELL: \$175 EA.

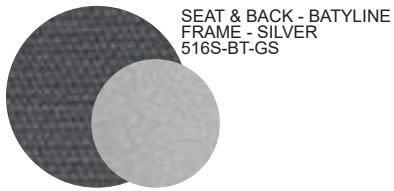
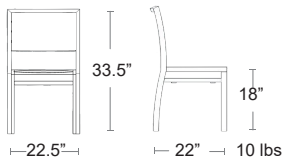

SEAT & BACK - BATYLINE  
FRAME - SILVER  
516S-BT-GS

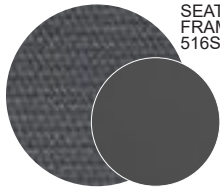

SEAT & BACK - BATYLINE  
FRAME - BLACK  
516S-BT-GA





## Marco Polywood

Square tubular aluminum frame • E-Plated Powder Coat finish  
• Polywood Seat & Back

**LIST: \$270 EA.    SELL: \$175 EA.**

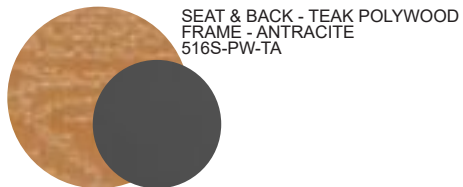
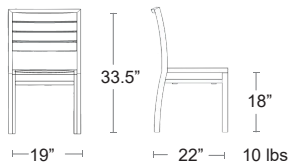

SEAT & BACK - TEAK POLYWOOD  
FRAME - ANTRACITE  
516S-PW-TA



SEAT & BACK - GREY POLYWOOD  
FRAME - ANTRACITE  
516S-PW-GA

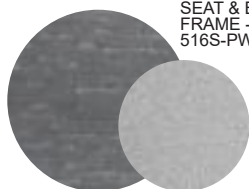

SEAT & BACK - GREY POLYWOOD  
FRAME - SILVER  
516S-PW-GS

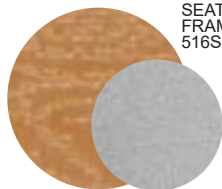

SEAT & BACK - TEAK POLYWOOD  
FRAME - SILVER  
516S-PW-TS





## Island Faux Wood

Faux Wood seat & back • Aluminum powder coated frame



**LIST: \$300 EA.    SELL: \$195 EA.**

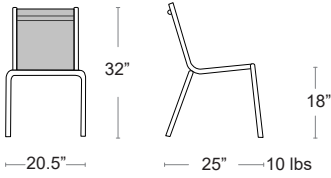



# Island Sling

Batyline seat & back • Aluminum powder coated frame



LIST: \$330 EA.    SELL: \$215 EA.

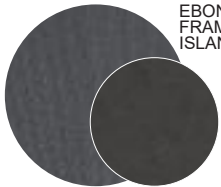
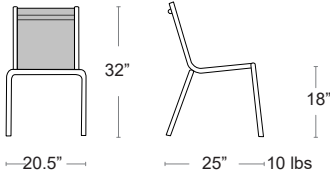

EBONY BATYLINE SLING  
FRAME - BLACK  
ISLAND-S-BLK-EBO



ASH BATYLINE SLING  
FRAME - SAND  
ISLAND-S-SND-ASH





# Adico #786A

Tubular steel frame • Solid steel seat & back • E-Plated Powder Coat finish



**LIST: \$380 EA.**

**SELL: \$250 EA.**

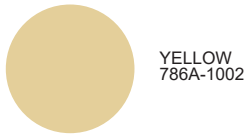
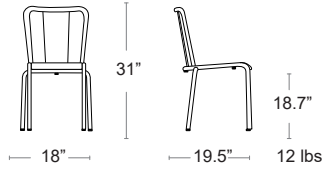

YELLOW  
786A-1002



WHITE  
786A-1310

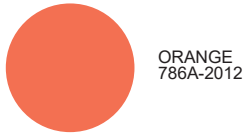

ORANGE  
786A-2012

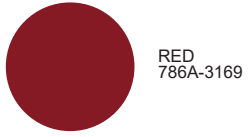

RED  
786A-3169

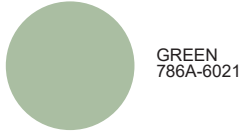

GREEN  
786A-6021

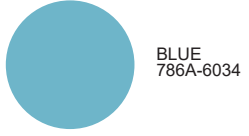

BLUE  
786A-6034

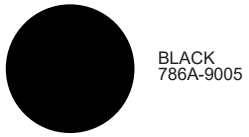

BLACK  
786A-9005



# Marco Polywood Bench

Square tubular aluminum frame • E-Plated Powder Coat finish  
• Polywood Seat & Back

LIST: \$550 EA.    SELL: **\$360 EA.**

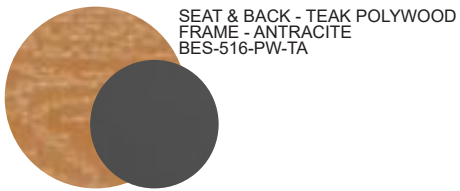
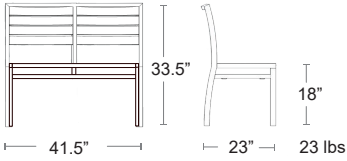

SEAT & BACK - TEAK POLYWOOD  
FRAME - ANTRACITE  
BES-516-PW-TA



SEAT & BACK - GREY POLYWOOD  
FRAME - ANTRACITE  
BES-516-PW-GA

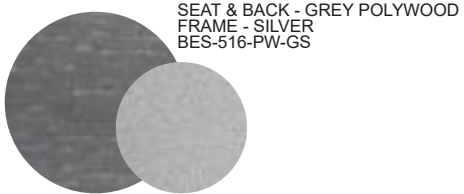

SEAT & BACK - GREY POLYWOOD  
FRAME - SILVER  
BES-516-PW-GS



SEAT & BACK - TEAK POLYWOOD  
FRAME - SILVER  
BES-516-PW-TS



Connecting hardware included with orders of 2 or more

## Rio Bench Aluminum

Aluminum frame & seat • E-Plated Powder Coat finish • Adjustable height feet



**LIST: \$1040 EA.    SELL: \$675 EA.**

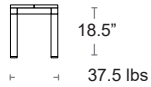
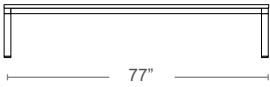
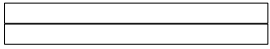

13.5"

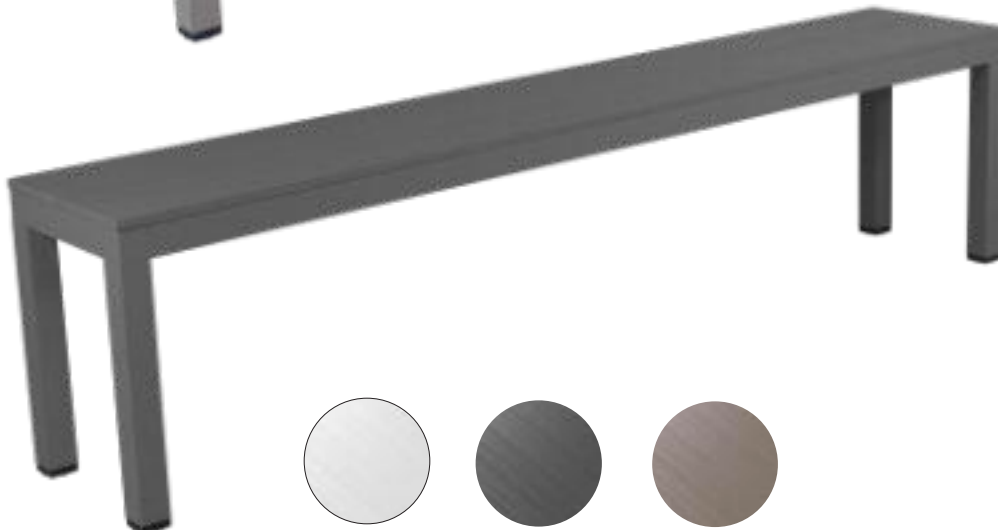

BIANCO  
49053.00



ANTRACITE  
49052.02



TORTORA  
49059.10



# Side Chair Cushions



Sunbrella 100% Solution dyed acrylic • Zippered removable cover • Washable  
Custom Sunbrella colors available for a 25% Surcharge • Expect 3-4 weeks for delivery

**LIST: \$70 EA.    SELL: \$45 EA.**



SPECTRUM  
DAFFODIL  
-48024

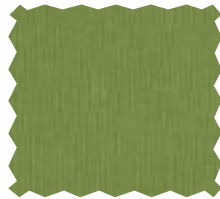

SPECTRUM  
CILANTRO  
-48022



SPECTRUM  
EGGSHELL  
-48018



CANVAS  
GRANITE  
-5402



SPECTRUM  
CHERRY  
-48096



SPECTRUM  
CARBON  
-48085



CANVAS  
REGATTA  
-5493



CANVAS  
ARUBA  
-5416



CANVAS  
MELON  
-5415

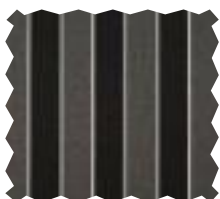

PEYTON  
GRANITE  
-56075

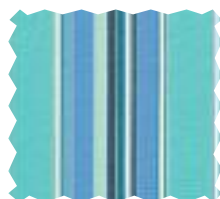

DOLCE  
OASIS  
-56001



DOLCE  
MANGO  
-56000



CABANA  
CLASSIC  
-58030

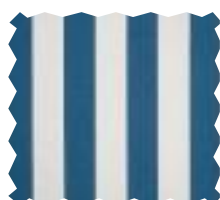



CABANA  
REGATTA  
-58029



MILANO  
CHAR  
-56079



Enhance patios, rooftops, & outdoor seating areas with custom commercial-grade cushions made with Sunbrella® performance fabric. Durable, professional seating solutions available for restaurants, hotels, resorts, offices & more.

-  Built for High Traffic • withstands daily use in busy commercial environments
-  UV-Protected & Fade-Resistant • maintains a polished, professional look, season after season
-  Weather-Resistant & Easy to Maintain • designed to handle spills, rain, & outdoor exposure
-  Custom Branding Options - wide range of fabrics, colors, & styles to align with your brand identity

Deliver comfort, style, and long-lasting quality to your guests, clients, & staff.

 For fabric samples, bulk pricing, & custom solutions contact: [samplerequest@bumoutdoor.ca](mailto:samplerequest@bumoutdoor.ca)







# BAR STOOLS



# Stack Maxi

Uniformly colored polypropylene & fiberglass • UV Protected



LIST: \$170 EA.

SELL: \$110 EA.

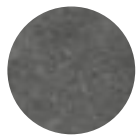
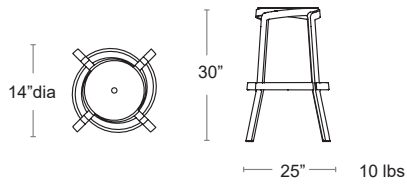

BASALTO  
40358.25

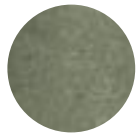

CACTUS  
40358.27



GESSO  
40358.29



TERRA  
40358.44



**NARDI**  
YOUR OUTDOOR LIVING  
MADE IN ITALY

## Lido

Uniformly colored polypropylene & fiberglass • UV Protected

LIST: \$190 EA.

SELL: **\$125 EA.**

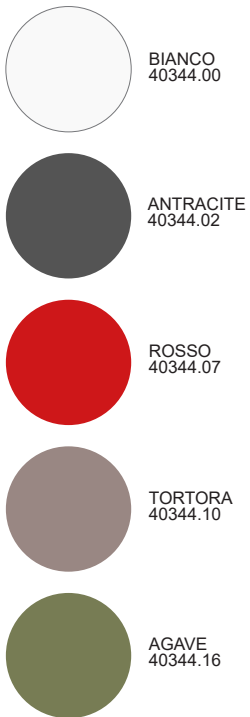
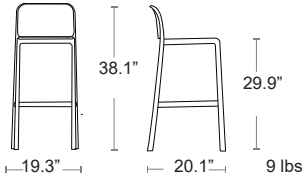

**NARDI**  
YOUR OUTDOOR LIVING  
MADE IN ITALY



## Faro

Uniformly colored polypropylene & fiberglass • UV Protected

LIST: \$190 EA.    **SELL: \$125 EA.**

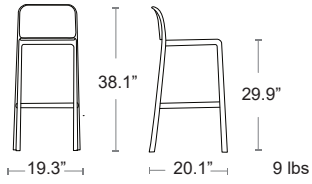

# Cassia

Uniformly colored polypropylene & fiberglass • UV Protected



LIST: \$210 EA.    **SELL: \$140 EA.**

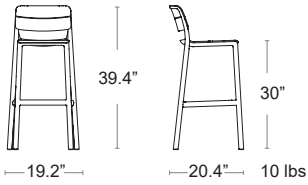

-  ANTRACITE  
40362.02
-  CAPPUCINO  
40362.14
-  CORDA  
40362.24
-  BASALTO  
40362.25  
*regeneration* 
-  CACTUS  
40362.27  
*regeneration* 
-  BORGOGNA  
40362.38
-  MAYA  
40362.42
-  TABACCO  
40362.53

**NARDI**  
YOUR OUTDOOR LIVING  
MADE IN ITALY



## Trill

Uniformly colored polypropylene & fiberglass • UV Protected

LIST: \$210 EA.

SELL: \$140 EA.

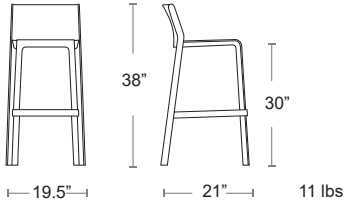

-  BIANCO  
40350.00
-  ANTRACITE  
40350.02
-  GRIGIO  
40350.03
-  TORTORA  
40350.10
-  AGAVE  
40350.16
-  OTTANIO  
40350.49
-  SENAPE  
40350.56
-  TABACCO  
40350.53



## Trill Counter

Uniformly colored polypropylene & fiberglass • UV Protected



LIST: \$210 EA

SELL: **\$140 EA**

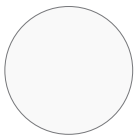
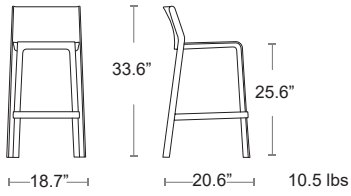

BIANCO  
40353.00

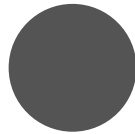

ANTRACITE  
40353.02

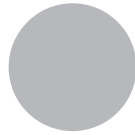

GRIGIO  
40353.03

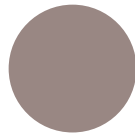

TORTORA  
40353.10



AGAVE  
40353.16



OTTANIO  
40353.49



SENAPE  
40353.56



TABACCO  
40353.53



**NARDI**  
YOUR OUTDOOR LIVING  
MADE IN ITALY

## Doga

Uniformly colored polypropylene & fiberglass • UV Protected



LIST: \$210 EA.

SELL: \$140 EA.

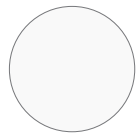
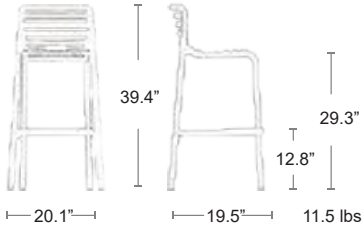

BIANCO  
40348.00

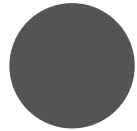

ANTRACITE  
40348.02

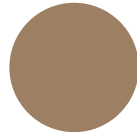

CAPPUCINO  
40348.14



MENTA  
40348.15



AGAVE  
40348.16



PERA  
40348.18



MARSALA  
40348.21



TABACCO  
40348.53



**NARDI**  
YOUR OUTDOOR LIVING  
MADE IN ITALY

## Net

Uniformly colored polypropylene & fiberglass • UV Protected

LIST: \$220 EA.    SELL: **\$145 EA.**

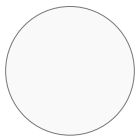
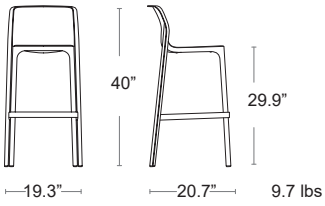

BIANCO  
40355.00

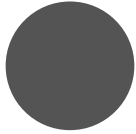

ANTRACITE  
40355.02



SALICE  
40355.04

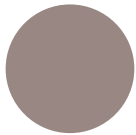

TORTORA  
40355.10



SENAPE  
40355.56



CORALLO  
40355.75



**NARDI**  
YOUR OUTDOOR LIVING  
MADE IN ITALY



## Net Counter

Uniformly colored polypropylene & fiberglass • UV Protected

LIST: \$220 EA

SELL: **\$145 EA**

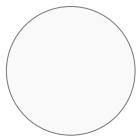
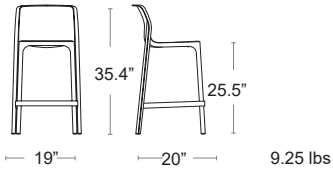

BIANCO  
40356.00



ANTRACITE  
40356.02



SALICE  
40356.04

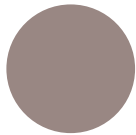

TORTORA  
40356.10



SENAPE  
40356.56



CORALLO  
40356.75





## Marco Wicker - Armless

Square tubular aluminum frame • E-Plated Powder Coat finish  
• Viro Wicker Seat & Back

**LIST: \$320 EA.    SELL: \$210 EA.**

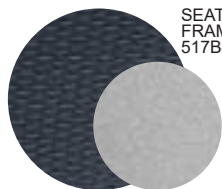
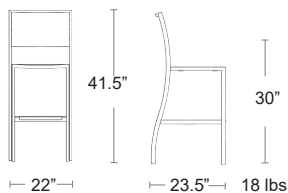

SEAT & BACK - VIRO GRAPHITE  
FRAME - SILVER  
517B-SW-BS

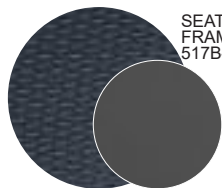

SEAT & BACK - VIRO GRAPHITE  
FRAME - ANTRACITE  
517B-SW-BA





## Marco Sling - Armless

Square tubular aluminum frame • E-Plated Powder Coat finish  
• Batyline Seat & Back

**LIST: \$320 EA.    SELL: \$210 EA.**

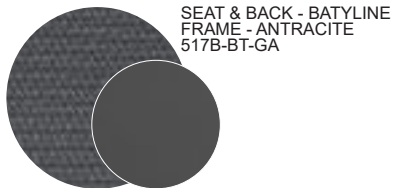
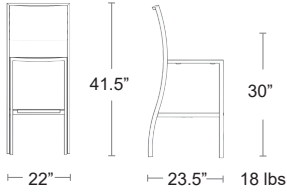



## Marco Polywood - Armless

Square tubular aluminum frame • E-Plated Powder Coat finish  
• Polywood Seat & Back

**LIST: \$320 EA.    SELL: \$210 EA.**

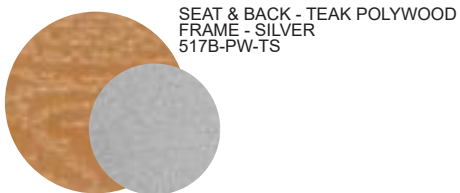
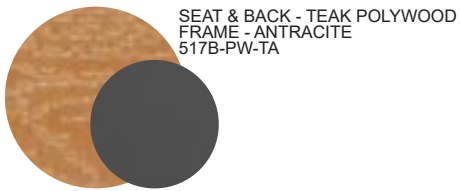
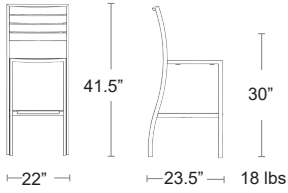



## Marco Wicker - Arm

Square tubular aluminum frame • E-Plated Powder Coat finish  
• Viro Wicker Seat & Back • Polywood armrests

LIST: \$370 EA.    SELL: **\$240 EA.**

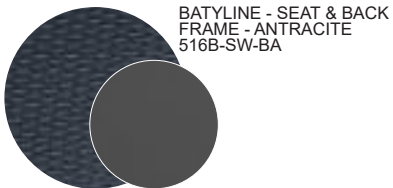
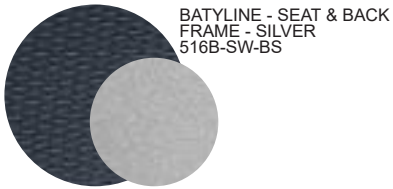
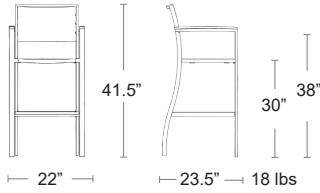



## Marco Sling - Arm

Square tubular aluminum frame • E-Plated Powder Coat finish  
• Batyline Seat & Back • Polywood armrests

**LIST: \$370 EA.    SELL: \$240 EA.**

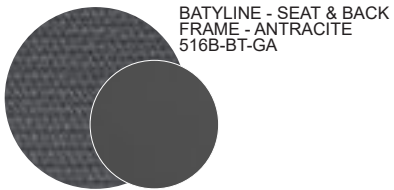
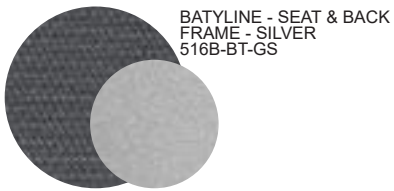
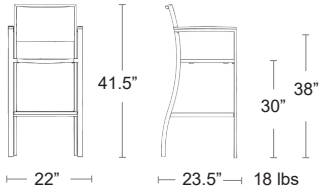



## Marco Polywood - Arm

Square tubular aluminum frame • E-Plated Powder Coat finish  
• Polywood Seat, Back & Armrests

**LIST: \$370 EA.    SELL: \$240 EA.**

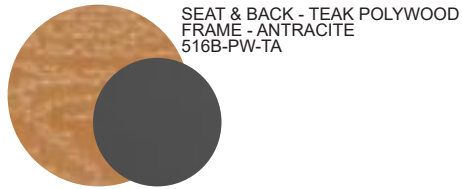
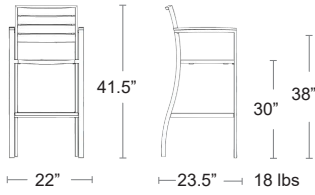

SEAT & BACK - TEAK POLYWOOD  
FRAME - ANTRACITE  
516B-PW-TA

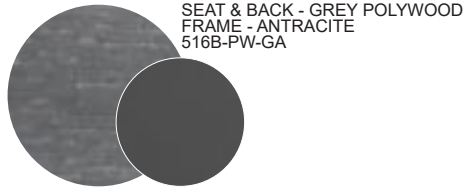

SEAT & BACK - GREY POLYWOOD  
FRAME - ANTRACITE  
516B-PW-GA



SEAT & BACK - GREY POLYWOOD  
FRAME - SILVER  
516B-PW-GS

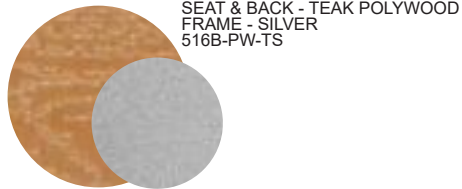

SEAT & BACK - TEAK POLYWOOD  
FRAME - SILVER  
516B-PW-TS





## Island Faux Wood

Faux Wood seat & back • Aluminum powder coated frame

LIST: \$340 EA.    SELL: \$220 EA.

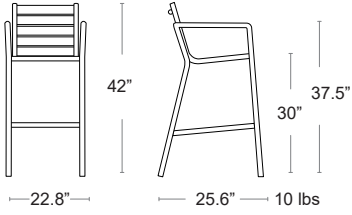

FAUX WOOD GREY  
FRAME - EBONY  
ISLAND-B-BLK-FWG



FAUX WOOD TEAK  
FRAME - SAND  
ISLAND-B-SND-FWT





# Island Sling

Batyline seat & back • Aluminum powder coated frame

LIST: \$370 EA.

SELL: \$240 EA.

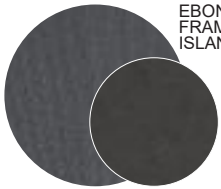
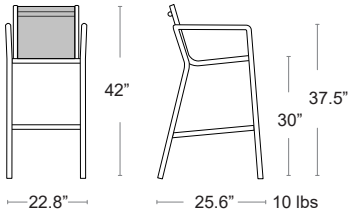

EBONY BATYLINE SLING  
FRAME - BLACK  
ISLAND-B-BLK-EBO

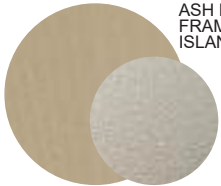

ASH BATYLINE SLING  
FRAME - SAND  
ISLAND-B-SND-ASH





## Parisian

Welded Aluminum frame • Wood-look finish • All-Weather wicker seat & back



LIST: \$390 EA.    SELL: **\$255 EA.**

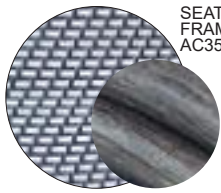
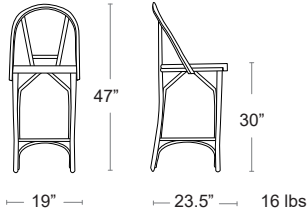

SEAT & BACK - BLACK & WHITE  
FRAME - TEAK  
AC3531N17RAT





## Capri

All-Weather Rope back & arms • Round tubular aluminum frame • E-Plated Powder Coat finish • Textaline seat cushion

LIST: \$400 EA.    SELL: **\$260 EA.**

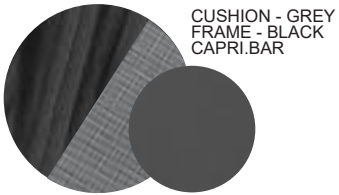
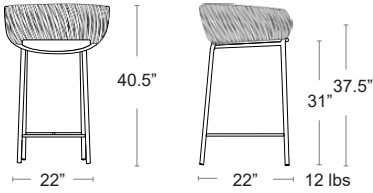

CUSHION - GREY  
FRAME - BLACK  
CAPRI.BAR





## Adico 786B

Tubular steel frame • Solid steel seat & back • E-Plated Powder Coat finish



LIST: \$470 EA.    SELL: **\$305 EA.**

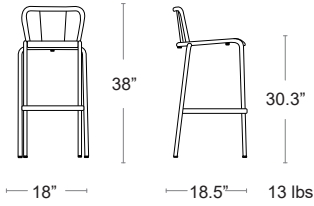

YELLOW  
786B-1002

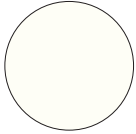

WHITE  
786B-1310



ORANGE  
786B-2012



RED  
786B-3169



GREEN  
786B-6021



BLUE  
786B-6034

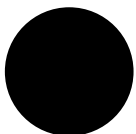

BLACK  
786B-9005

# HOUE

MADE IN DENMARK



## ReCLIPS

Resin slats made from 97% recycled polypropylene • UV protected • Round tubular aluminum frame • E-Plated Powder Coat finish

LIST: \$500 EA.    SELL: **\$325 EA.**

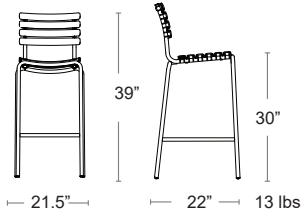

BLACK  
22305-2024



# HOUE

MADE IN DENMARK



## ReCLIPS Counter

Resin slats made from 97% recycled polypropylene • UV protected • Round tubular aluminum frame • E-Plated Powder Coat finish

LIST: \$500 EA.    SELL: **\$325 EA.**

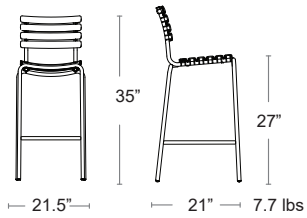

BLACK  
22309-2024





# TABLES: DINING HEIGHT





# Spritz

Solid resin & fiberglass top with center column & three spokes • UV Protected



LIST: \$200 EA.    SELL: **\$130 EA.**

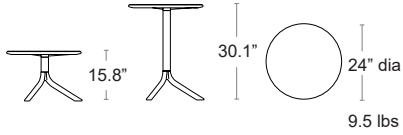

TABLES: DINING HEIGHT



LOUNGE



DINING

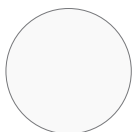

BIANCO  
40058.  
00

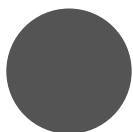

ANTRACITE  
40058.  
02



SALICE  
40058.  
04



TORTORA  
40058.  
10



AGAVE  
40058.  
16



CORDA  
40058.  
24



SENAPE  
40058.  
56



CORALLO  
40058.  
75



## Clip

Resin & fiberglass top • Tubular resin & fiberglass legs • UV Protected

### Clip 70

40084 + COLOR CODE

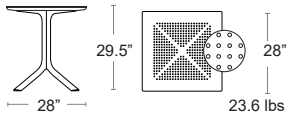

**LIST: \$370 EA.**  
**SELL: \$240 EA.**



### Clip 80

40082 + COLOR CODE

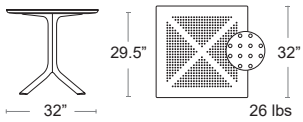

**LIST: \$380 EA.**  
**SELL: \$250 EA.**

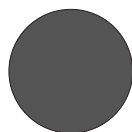
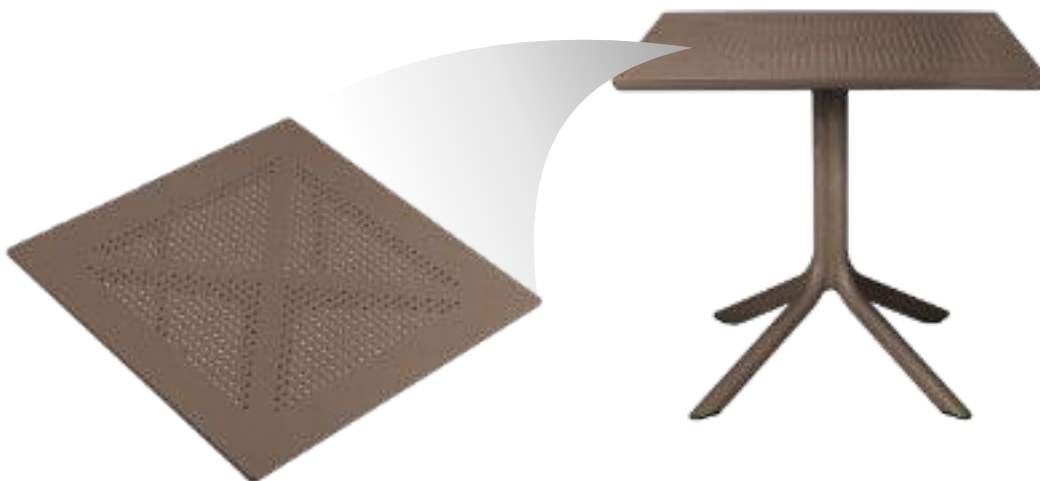

ANTRACITE  
.02

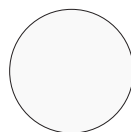

BIANCO  
.00

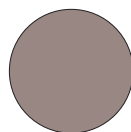

TORTORA  
.10



AGAVE  
.16

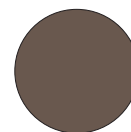

TABACCO  
.53



Combo

Regenerated uniformly colored fiberglass polypropylene resins • UV protected •  
Matte finish • Recyclable resin

TABLES: DINING HEIGHT

Combo 60

40030 + COLOR CODE

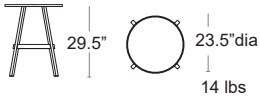

LIST: \$350 EA.  
SELL: \$230 EA.

Combo 70

40032 + COLOR CODE



LIST: \$400 EA.  
SELL: \$260 EA.

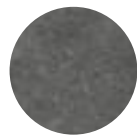

BASALTO  
.25



CACTUS  
.27

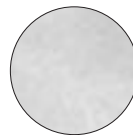

GESSO  
.29



TERRA  
.44



## Cube Collection

Tubular legs in coated aluminum · DurelTOP in polypropylene tabletop · UV Protected

### Cube Rectangle

#### Cube 120

47652.02

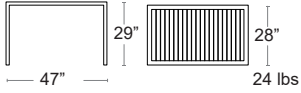

**LIST: \$570 EA.**

**SELL: \$370 EA.**

#### Cube 140

47752.02

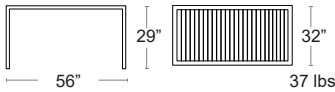

**LIST: \$630 EA.**

**SELL: \$410 EA.**



### Cube Square

#### Cube 70

47852.02

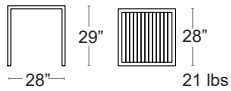

**LIST: \$410 EA.**

**SELL: \$270 EA.**

#### Cube 80

48052.02

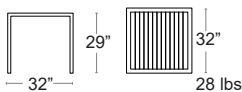

**LIST: \$440 EA.**

**SELL: \$285 EA.**



**SPECIAL ORDER**



ANTRACITE  
.02

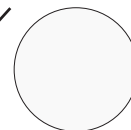

BIANCO  
.00

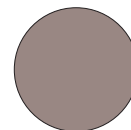

TORTORA  
.10

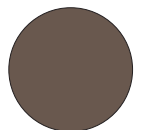

TABACCO  
.53



# Marco Polywood Collection

Square Tubular Aluminum frame · E-plated Powder Coat finish · Polywood slats · Extra slat with umbrella hole included if applicable



## Marco Polywood Rectangle

### Marco 24" x 32"

DT516-23Q + COLOR CODE

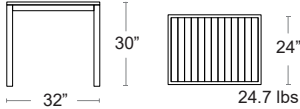

**LIST: \$450 EA.**  
**SELL: \$295 EA.**



### Marco 48" x 32"

DT516-48Q + COLOR CODE

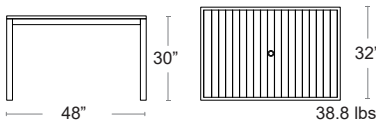

**LIST: \$650 EA.**  
**SELL: \$425 EA.**



### Marco 55" x 32"

DT516-55Q + COLOR CODE

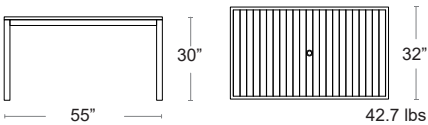

**LIST: \$740 EA.**  
**SELL: \$480 EA.**

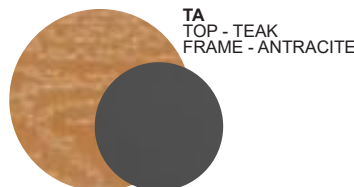



# Marco Polywood Square



## Marco 32" Square

DT516-32S + COLOR CODE

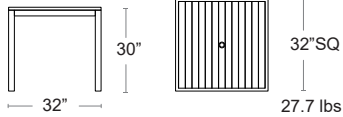

**LIST: \$540 EA.**  
**SELL: \$350 EA.**

## Marco 36" Square

DT516-36S + COLOR CODE

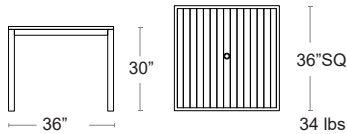

**LIST: \$600 EA.**  
**SELL: \$390 EA.**

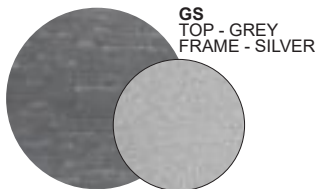

**GS**  
TOP - GREY  
FRAME - SILVER

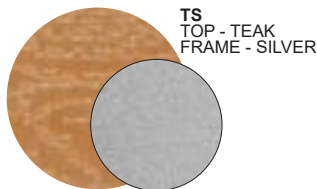

**TS**  
TOP - TEAK  
FRAME - SILVER

**\*PLEASE NOTE** This product has high UV additives to prevent fading, however in some instances, drinking glasses left on the table in the sun can act as a magnifying glass and create small burn holes in the Polywood. This product is recommended for use where glassware is not used\*



## Adico 5028

Tubular Steel Base • E-Plated Powder Coat finish • Okoume Marine Plywood Top  
Industrial Clear Outdoor Epoxy • 2 leveler & 2 regular feet



### Adico 55" x 28"

5028-140X70RECT

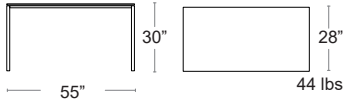

**LIST: \$1440 EA.**  
**SELL: \$935 EA.**



### Adico 28" Square

5028-70SQ

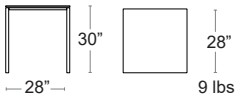

**LIST: \$620 EA.**  
**SELL: \$405 EA.**

### Adico 36" Square

5028-90SQ

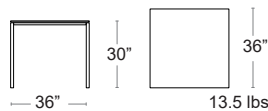

**LIST: \$1020 EA.**  
**SELL: \$665 EA.**



TOP - OKOUME PLYWOOD  
FRAME - BLACK

## Piave Collection

Coated aluminum frame • Solid textured HPL top • UV Protected



### Piave 120



ANTRACITE • 50452.00.352  
TORTORA • 50459.00.359  
TABACCO • 50467.00.367  
CORDA • 50469.00.369

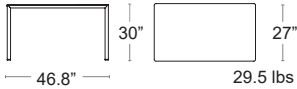

**LIST: \$1120 EA.**

**SELL: \$730 EA.**

### Piave Rectangle



### Piave 140



ANTRACITE • 50352.00.352  
TORTORA • 50359.00.359  
TABACCO • 50367.00.367  
CORDA • 50369.00.369

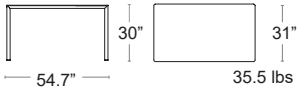

**LIST: \$1210 EA.**

**SELL: \$785 EA.**



### Piave 160



ANTRACITE • 50252.00.352  
TORTORA • 50259.00.359  
TABACCO • 50267.00.367  
CORDA • 50269.00.369

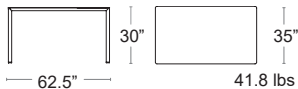

**LIST: \$1510 EA.**

**SELL: \$985 EA.**



ANTRACITE



TORTORA



TABACCO



CORDA

## Piave Collection

Coated aluminum frame • Solid textured HPL top • UV Protected•



### Piave Square



#### Piave 70

ANTRACITE • 49752.00.352  
TORTORA • 49759.00.359  
TABACCO • 49767.00.367  
CORDA • 49769.00.369

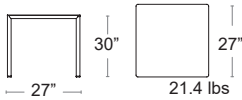

**LIST: \$800 EA.**

**SELL: \$520 EA.**



#### Piave 80

ANTRACITE • 49852.00.352  
TORTORA • 49859.00.359  
TABACCO • 49867.00.367  
CORDA • 49869.00.369

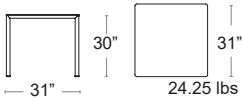

**LIST: \$870 EA.**

**SELL: \$565 EA.**



#### Piave 90



ANTRACITE • 50152.00.352  
TORTORA • 50159.00.359  
TABACCO • 50167.00.367  
CORDA • 50169.00.369

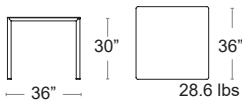

**LIST: \$1110 EA.**

**SELL: \$725 EA.**

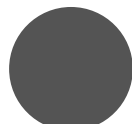

ANTRACITE



TORTORA



TABACCO



CORDA

## Rio 140 Resin Extendable Table

Aluminum frame & legs · E-plated Powder Coat finish · Resin tabletop · UV Protected · Removeable leaf nests under table · Seats 6-8

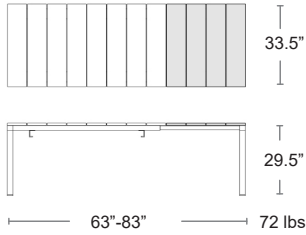

**LIST: \$1410 EA.**    **SELL: \$920 EA.**

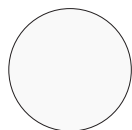

BIANCO  
48353.00

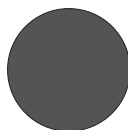

ANTRACITE  
48352.02

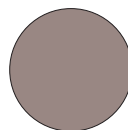

TORTORA  
48359.10

**NARDI**  
YOUR OUTDOOR LIVING  
MADE IN ITALY

## Rio 210 Resin Extendable

Aluminum frame & legs · E-plated Powder Coat finish · Resin tabletop · UV Protected · Removeable leaf nests under table · Seats 8-10

LIST: \$1720 EA.     **SELL: \$1120 EA.**

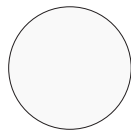
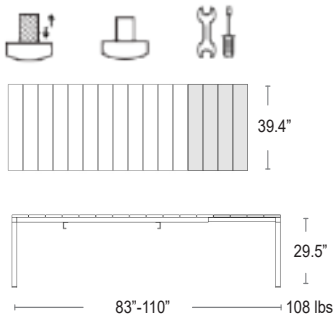

BIANCO  
48253.00

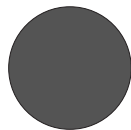

ANTRACITE  
48252.02

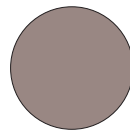

TORTORA  
48259.10

## Tevere 147 Extendable

Uniformly colored recyclable fiberglass polypropylene resin table top • UV Protected • Coated Aluminum Frame • Seats 6-8



**LIST: \$1860 EA.    SELL: \$1210 EA.**

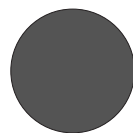
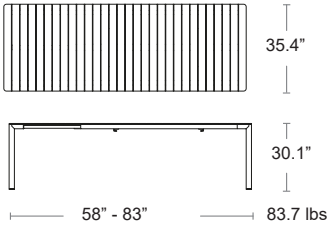

ANTRACITE  
49452.02



TORTORA  
49459.10



CORDA  
49469.24



TERRA  
49468.44



**NARDI**  
YOUR OUTDOOR LIVING  
MADE IN ITALY

## Rio 210 Aluminum Fix

Aluminum frame & legs • Aluminum tabletop • E-plated Powder Coat finish • UV Protected • Seats 10

LIST: \$1910 EA.

SELL: **\$1240 EA.**

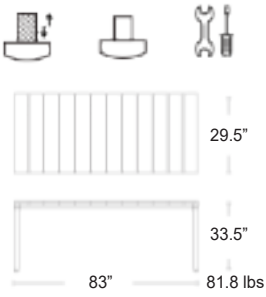

BIANCO  
49153.00



ANTRACITE  
49152.02



TORTORA  
49159.10

**NARDI**  
YOUR OUTDOOR LIVING  
MADE IN ITALY

## Rio 140 Aluminum Extendable

Aluminum frame & legs • Aluminum tabletop • E-plated Powder Coat finish • UV Protected • Removeable leaf nests under table • Seats 6-8

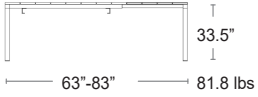

**LIST: \$2060 EA.    SELL: \$1340 EA.**



BIANCO  
48653.00



ANTRACITE  
48652.02



TORTORA  
48659.10

## Tevere 210 Extendable

Uniformly colored recyclable fiberglass polypropylene resin table top • UV Protected • Coated Aluminum Frame • Seats 8-10

LIST: \$2380 EA.    SELL: **\$1550 EA.**

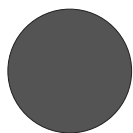
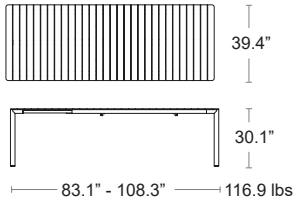

ANTRACITE  
49652.02



TORTORA  
49659.10



CORDA  
49669.24



TERRA  
49668.44



## Rio 210 Aluminum Extendable

Aluminum frame & legs • Aluminum tabletop • E-plated Powder Coat finish • UV Protected • Removeable leaf nests under table • Seats 8-10

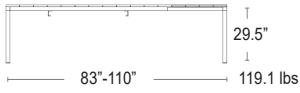

**LIST: \$2720 EA.    SELL: \$1770 EA.**



BIANCO  
48853.00



ANTRACITE  
48852.02



TORTORA  
48859.10



## Marco Polywood Cluster ADA

- Round tubular steel frame • E-Plated Powder Coat finish
- Polywood & Aluminum Seats & Tabletop • Built-in 1.5" umbrella mount •
- MUST be bolted down • Hardware included

LIST: \$1900 EA.    **SELL: \$1235 EA.**

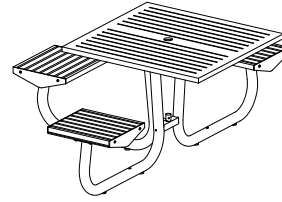
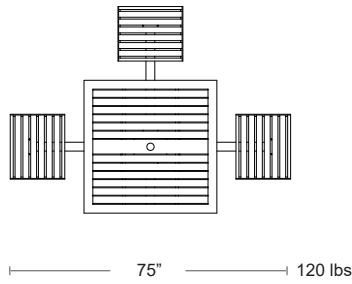
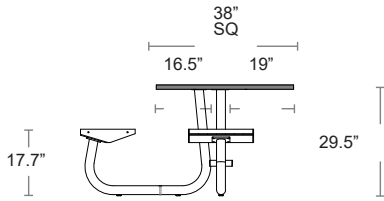

**\*PLEASE NOTE** This product has high UV additives to prevent fading, however in some instances, drinking glasses left on the table in the sun can act as a magnifying glass and create small burn holes in the Polywood. This product is recommended for use where glassware is not used\*

TOP & SEATS GREY POLYWOOD  
FRAME ANTRACITE  
CS-7113-PW-GA-ADA

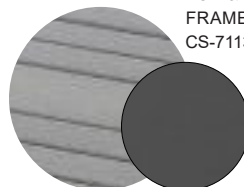



## Marco Polywood Cluster 4 Seat

- Round tubular steel frame • E-Plated Powder Coat finish
- Polywood Seats & Tabletop • Built-in 1.5" umbrella mount •
- MUST be bolted down • Hardware included

LIST: \$1970 EA.     **SELL: \$1280 EA.**

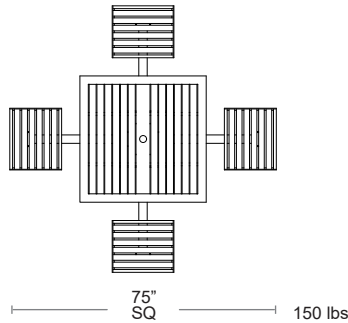
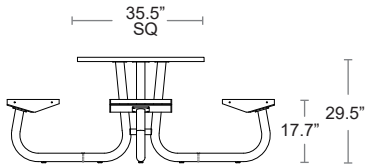

**\*PLEASE NOTE** This product has high UV additives to prevent fading, however in some instances, drinking glasses left on the table in the sun can act as a magnifying glass and create small burn holes in the Polywood. This product is recommended for use where glassware is not used\*

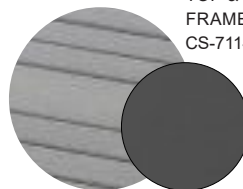

TOP & SEATS GREY POLYWOOD  
FRAME ANTRACITE  
CS-7114-PW-GA



## Marco Polywood Round Cluster Seat

Rectangular tubular steel frame • E-Plated Powder Coat finish  
• Polywood & Aluminum Seats & Tabletop • Seats 8 • 1.5" Umbrella hole •  
Requires umbrella base if umbrella is used • MUST be bolted down •  
Hardware included

**LIST: \$2400 EA.    SELL: \$1560 EA.**

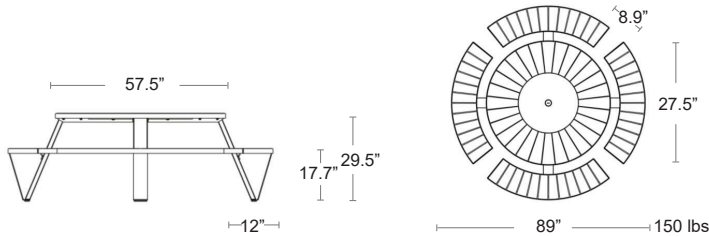

**\*PLEASE NOTE** This product has high UV additives to prevent fading, however in some instances, drinking glasses left on the table in the sun can act as a magnifying glass and create small burn holes in the Polywood. This product is recommended for use where glassware is not used\*

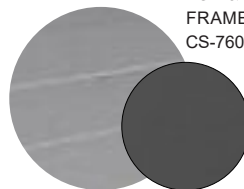

TOP & SEATS GREY POLYWOOD  
FRAME ANTRACITE  
CS-760-PW-GA





# TABLES: BAR HEIGHT



## Combo Bar

Regenerated uniformly colored fiberglass polypropylene resins • UV Protected • Matte finish • Recyclable resin



### Combo Bar 60

40030 + 40031 + COLOR CODE

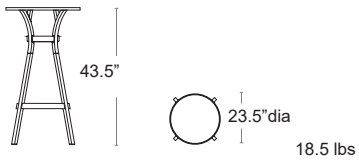

**LIST: \$450 EA.**  
**SELL: \$295 EA.**

### Combo Bar 70

40032 + 40031 + COLOR CODE

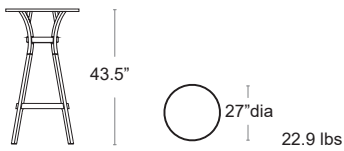

**LIST: \$490 EA.**  
**SELL: \$320 EA.**

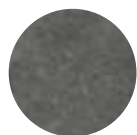

**BASALTO**  
.25

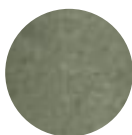

**CACTUS**  
.27

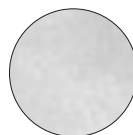

**GESSO**  
.29



**TERRA**  
.44



## Cube Bar Collection

Resin & fiberglass slat top • Tubular aluminum legs  
• E-Plated Powder Coat finish • UV Protected

### Cube Rectangle



### Cube 120

47652.02+46852.02

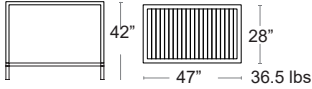

LIST: \$780 EA.

SELL: \$510 EA.

### Cube 140

47752.02+46952.02

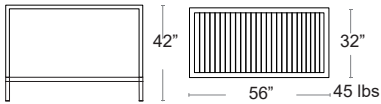

LIST: \$850 EA.

SELL: \$555 EA.

### Cube Square



### Cube 70

47852.02+47952.02

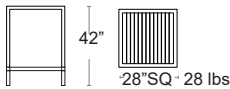

LIST: \$600 EA.

SELL: \$390 EA.

### Cube 80

48052.02+48152.02



LIST: \$630 EA.

SELL: \$410 EA.



## Piave 70 Bar

Coated aluminum frame • Solid textured HPL top • UV Protected



LIST: \$1260 EA.    **SELL: \$820 EA.**

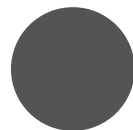
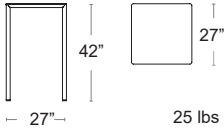

ANTRACITE  
51052.00.352



TORTORA  
51059.00.359



TABACCO  
51067.00.367



CORDA  
51069.00.369



## Adico Bar Collection

Tubular Steel Base • E-Plated Powder Coat finish • Okoume Marine Plywood Top  
Industrial Clear Outdoor Epoxy • 2 leveler & 2 regular feet

### Adico 55" x 24"

IKA-A-140X60RECT

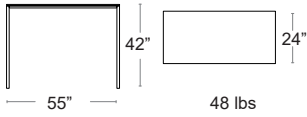

**LIST: \$1560 EA.**

**SELL: \$1015 EA.**

### Adico 55" x 28"

IKA-A-140X70RECT

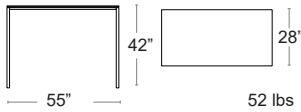

**LIST: \$1710 EA.**

**SELL: \$1115 EA.**

### Adico 28" Square

IKA-A-70SQ

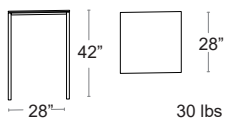

**LIST: \$1050 EA.**

**SELL: \$685 EA.**

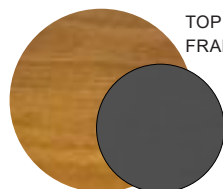

TOP - OKOUME PLYWOOD  
FRAME - BLACK



# Stone Ceramic Bar

Aluminum Frame • E-Plated Powder Coat finish • Ceramic Tabletop Surface

LIST: \$1280 EA.    **SELL: \$835 EA.**

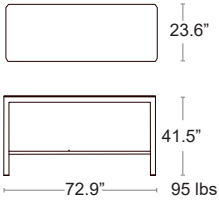

95 lbs



TOP - CERAMIC MARBLE  
FRAME - BLACK  
STONE-CG-T-110CBC-BLACK

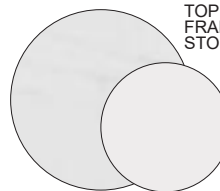

TOP - CERAMIC MARBLE  
FRAME - WHITE  
STONE-CG-T-110CBC-WHITE

TABLES: BAR HEIGHT



## Stone Ceramic Counter

Aluminum Frame • E-Plated Powder Coat finish • Ceramic Tabletop Surface

LIST: \$1280 EA.    **SELL: \$835 EA.**

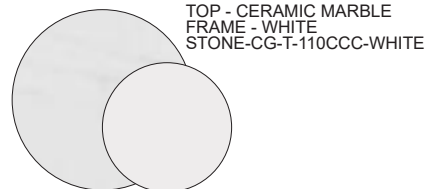
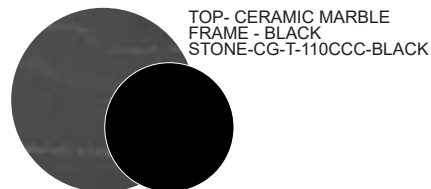
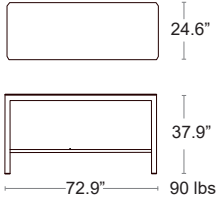











# TABLETOPS



## Tabletop & Base Fit Guide

\*None of these bases allow for umbrella pole

								
		24"x32"	48"x32"	32" Dia	30" Dia	24"	32"	36"
SINGLE DINING HEIGHT	CLIP DINING	★		★	★	★	★	
	FIORE DINING	★		★	★	★	★	
	FLUTE TILTING			★	★	★		
	IBISCO TILTING	★		★	★	★	★	
	FRASCA MAXI			★	★	★	★	★
	FRASCA MINI	★		★	★	★	★	
	TRAIL 27	★		★	★	★	★	★
	TRAIL 30	★		★	★	★	★	★
	LUNAR DINING SMALL	★		★	★	★	★	
	LUNAR DINING LARGE	★	★	★	★	★	★	★
	TERRACE DINING	★		★	★	★	★	★
DOUBLE DINING HEIGHT	TRAIL DINING DOUBLE		★					
	SCUDO TILTING		★					
SINGLE BAR HEIGHT	FIORE BAR	★		★	★	★		
	IBISCO TILTING	★		★	★	★		
	FRASCA TILTING	★		★	★	★		
	TRAIL 27 BAR			★	★	★		
	TRAIL 30 BAR	★		★	★	★	★	★
	TRAIL 27 COUNTER			★	★	★		
	TRAIL 30 COUNTER	★		★	★	★	★	★
	LUNAR BAR				★	★		
	TERRACE TILT BAR			★	★	★	★	★
DOUBLE BAR HEIGHT	SCUDO DOUBLE TILTING		★					

**NARDI SINGLE BASES CAN BE CUT DOWN TO A CUSTOM HEIGHT • \$40**

**DOUBLE BASE • \$90**

**OTHER BASES CANNOT BE CUT**







BUM COMMERCIAL FURNITURE WILL PROVIDE THE NECESSARY HARDWARE  
IF BOTH TOP & BASE  
ARE PURCHASED ON THE SAME PURCHASE ORDER.



## Marco Polywood Tabletops

100% Polymer Polywood tabletop, 1" thick • Moisture resistant • UV protected  
 • Works with any table base that is size appropriate

*Refer to Tabletop & Base Fit Guide, Page 113*

POLYWOOD GREY	POLYWOOD TEAK	SIZE		WGT.	LIST	SELL
MARCO-GR-48X32	MARCO-TK-48X32	48"x32"		36 lbs	\$370	<b>\$240</b>
MARCO-GR-24X32	MARCO-TK-24X32	24"x32"		17 lbs	\$230	<b>\$150</b>
MARCO-GR-36RD	MARCO-TK-36RD	36"		20 lbs	\$280	<b>\$185</b>
MARCO-GR-36SQ	MARCO-TK-36SQ	36" SQ		32 lbs	\$340	<b>\$220</b>
MARCO-GR-32SQ	MARCO-TK-32SQ	32" SQ		23 lbs	\$280	<b>\$185</b>
MARCO-GR-24SQ	MARCO-TK-24SQ	24" SQ		13 lbs	\$190	<b>\$125</b>



**\*PLEASE NOTE** This product has high UV additives to prevent fading, however in some instances, drinking glasses left on the table in the sun can act as a magnifying glass and create small burn holes in the Polywood. This product is recommended for use where glassware is not used\*



## Classic

1" Thick molded melamine • UV protected • Pre-drilled stainless steel inserts for easy attachment to Bum bases



Cut  
LIST:\$60 SELL:\$39

*Refer to Tabletop & Base Fit Guide, Page 113*



PINIE	PONDEROSA GREY	PONDEROSA WHITE	STRATTOS	WHITE	SIZE		WGT.	LIST	SELL
CLSC-PN 48X32	CLSC-PG 48X32	CLSC-PW 48X32	CLSC-ST 48X32	CLSC-WH 48X32	48"x32"		36 lbs	\$430	\$280
CLSC-PN 24X32	CLSC-PG 24X32	CLSC-PW 24X32	CLSC-ST 24X32	CLSC-WH 24X32	24"x32"		17 lbs	\$310	\$200
CLSC-PN 32RD	CLSC-PG 32RD	CLSC-PW 32RD	CLSC-ST 32RD	CLSC-WH 32RD	32"		20 lbs	\$270	\$175
CLSC-PN 36SQ	CLSC-PG 36SQ	CLSC-PW 36SQ	CLSC-ST 36SQ	CLSC-WH 36SQ	36"		32 lbs	\$380	\$250
CLSC-PN 32SQ	CLSC-PG 32SQ	CLSC-PW 32SQ	CLSC-ST 32SQ	CLSC-WH 32SQ	32"		23 lbs	\$320	\$210
CLSC-PN 24SQ	CLSC-PG 24SQ	CLSC-PW 24SQ	CLSC-ST 24SQ	CLSC-WH 24SQ	24"		13 lbs	\$210	\$135





## Compact HPL

½" Thick High pressure laminate top • =Slightly textured to reduce sliding • UV protected • Pre-drilled stainless steel inserts for easy attachment to Bum bases

*Refer to Tabletop & Base Fit Guide, Page 113*

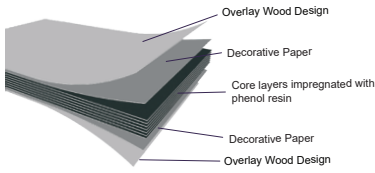

↑  
.5"  
↓



SILVER FABRIC	VINTAGE PINE	SIZE		WGT.	LIST	SELL
HPL-SF-48X32	HPL-VP-48X32	48"x32"		31 lbs	\$640	<b>\$415</b>
HPL-S- 24X32	HPL-VP-24X32	24"x32"		15 lbs	\$430	<b>\$280</b>
HPL-SF-36SQ	HPL-VP-36SQ	36"		25 lbs	\$500	<b>\$325</b>
HPL-SF-32SQ	HPL-VP-32SQ	32"		22 lbs	\$440	<b>\$285</b>
HPL-SF-24SQ	HPL-VP-24SQ	24"		12 lbs	\$330	<b>\$215</b>

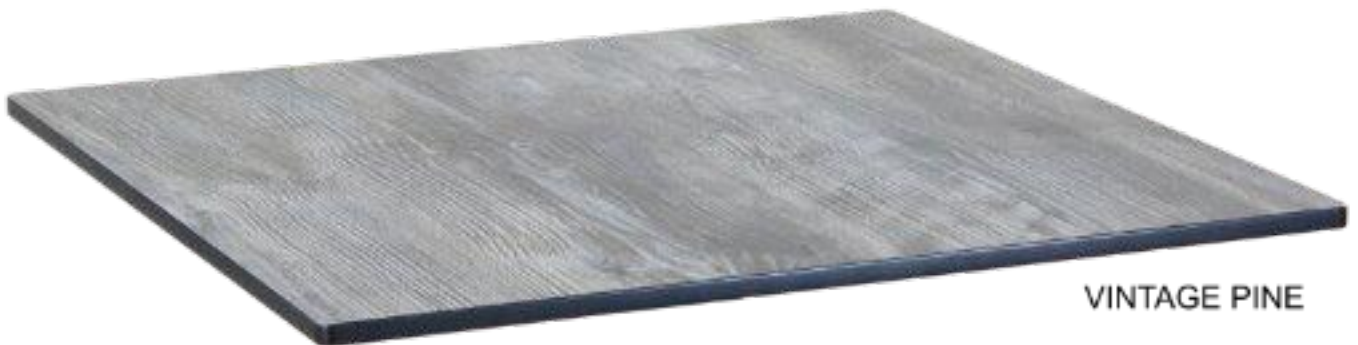

VINTAGE PINE



SILVER FABRIC



## Exteriorlit

½" Thick Poplar veneerboard • 1/16" HPL coating on both sides • UV protected • Attach to any base with self tapping screws



Cut  
LIST:\$50 SELL:\$33

*Refer to Tabletop & Base Fit Guide, Page 113*



↑  
1.2"  
↓

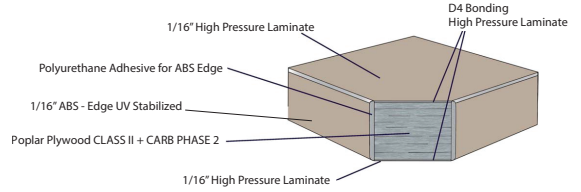

ATRIUM GREY	MARBLE CARRARA	MARBLE PIETRO	SILVER FABRIC	SIZE		WGT.	LIST	SELL
EXT-AG-48X32	EXT-CM-48X32	EXT-PM-48X32	EXT-SF-EX48X32	48"x32"		38 lbs	\$810	\$530
EXT-AG-24X32	EXT-CM-24X32	EXT-PM-24X32	EXT-SF-EX24X32	24"x32"		19 lbs	\$470	\$305
EXT-AG-30RD	EXT-CM-30RD	EXT-PM-30RD	EXT-SF-EX30RD	30"		20 lbs	\$610	\$395
EXT-AG-36SQ	EXT-CM-36SQ	EXT-PM-36SQ	EXT-SF-EX36SQ	36"		32 lbs	\$660	\$430
EXT-AG-32SQ	EXT-CM-32SQ	EXT-PM-32SQ	EXT-SF-EX32SQ	32"		25 lbs	\$570	\$370
EXT-AG-24SQ	EXT-CM-24SQ	EXT-PM-24SQ	EXT-SF-EX24SQ	24"		14 lbs	\$330	\$215



SILVER FABRIC



MARBLE CARRARA



ATRIUM GREY



MARBLE PIETRO









## Jakarta Teak

Solid natural Teak • Pre-drilled stainless steel inserts for easy attachment to Bum bases

*Refer to Tabletop & Base Fit Guide, Page 113*



T  
1"  
↓

	SIZE		WGT.	LIST	SELL
JKTA-TK-48X32	48"x32"		36 lbs	\$810	<del>\$530</del>
JKTA-TK-24X32	24"x32"		17 lbs	\$480	<del>\$315</del>
JKTA-TK-30RD	30"		15 lbs	\$430	<del>\$280</del>
JKTA-TK-36SQ	36"		30 lbs	\$650	<del>\$425</del>
JKTA-TK-32SQ	32"		23 lbs	\$530	<del>\$345</del>
JKTA-TK-24SQ	24"		13 lbs	\$390	<del>\$255</del>

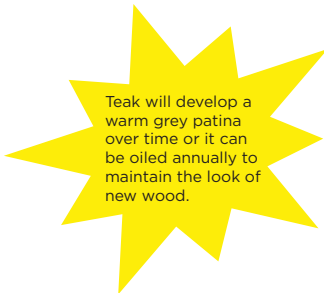

Teak will develop a warm grey patina over time or it can be oiled annually to maintain the look of new wood.





# DINING HEIGHT BASES





Refer to Tabletop & Base Fit Guide, Page 113



### Clip

Tubular resin & fiberglass legs • UV Protected

LIST: \$190 EA.    SELL: **\$125 EA.**

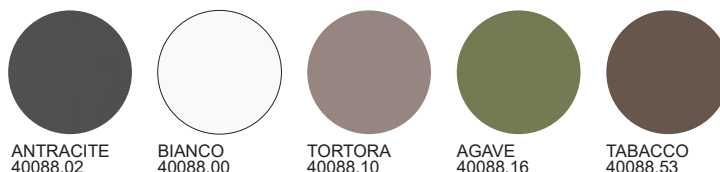
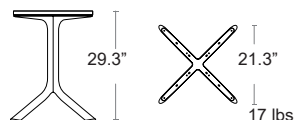

DINING HEIGHT BASES



### Fiore

Cast Aluminum • E-Plated Powder Coat finish  
• Specially Treated for High Salinity Environments

LIST: \$240 EA.    SELL: **\$155 EA.**

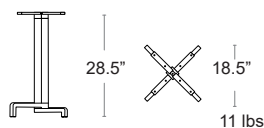

**IF YOU DON'T SEE WHAT YOU WANT,  
JUST ASK.**

**WE COLLABORATE  
WITH FACTORIES WORLDWIDE  
TO BRING YOUR VISION TO LIFE**

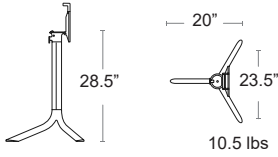

### Flute Tilt

Cast Aluminum • E-Plated Powder Coat finish  
• Specially Treated for High Salinity Environments

**LIST: \$280 EA.    SELL: \$185 EA.**

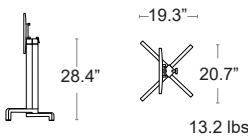
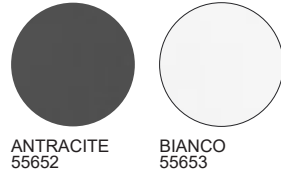

### Ibisco Tilt

Cast Aluminum • E-Plated Powder Coat finish  
• Specially Treated for High Salinity Environments

**LIST: \$300 EA.    SELL: \$195 EA.**

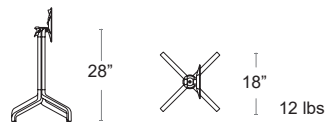

### Frasca Collection

Cast Aluminum • E-Plated Powder Coat finish  
• Specially Treated for High Salinity Environments

#### Mini Tilt

532 + COLOR CODE

**LIST: \$310 EA.    SELL: \$200 EA.**

#### Maxi

536 + COLOR CODE

**LIST: \$430 EA.    SELL: \$280 EA.**



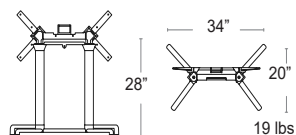

### Scudo Tilt Double

Cast Aluminum • E-Plated Powder Coat finish  
 • Specially Treated for High Salinity Environments

**LIST: \$440 EA.    SELL: \$285 EA.**



**SPECIAL ORDER**

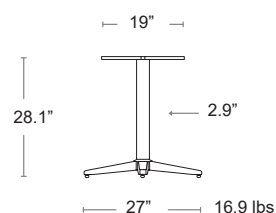
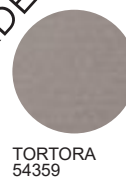

### Trail Collection

Steel · E-plated Powder Coat finish · Award-winning self-stabilizing mechanical system

#### Trail 27

TRST27BK-BLACK-DH  
**LIST: \$260 EA.**  
**SELL: \$170 EA.**

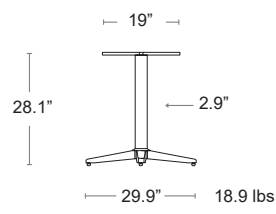

#### Trail 30

TRST30BK-BLACK -DH  
**LIST: \$300 EA.**  
**SELL: \$195 EA.**

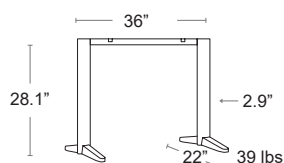

#### Trail Double

TTST22BK-BLACK -DH  
**LIST: \$390 EA.**  
**SELL: \$255 EA.**



DINING HEIGHT BASES

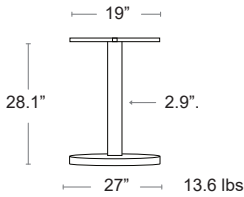

### Lunar Collection

Steel · E-plated Powder Coat finish · Disc shaped base  
• Award-winning self-stabilizing mechanical system



### Lunar 21 Small

LNST21BK-BLACK -DH

**LIST: \$360 EA.**

**SELL: \$235 EA.**



### Lunar 30 Large

LNST30BK-BLACK -DH

**LIST: \$630 EA.**

**SELL: \$410 EA.**

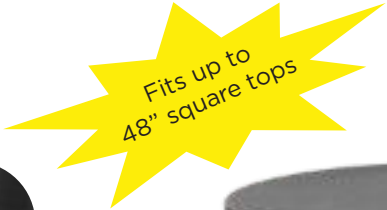
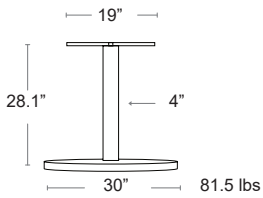

BLACK

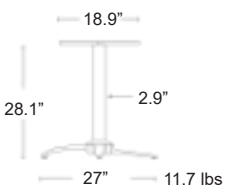

### Terrace 27 Tilt

Aluminum · E-plated Powder Coat finish ·  
Award-winning self-stabilizing mechanical system

**LIST: \$380 EA.**

**SELL: \$250 EA.**



BLACK  
TCAL27BK-BLACK -DH







# BAR HEIGHT BASES



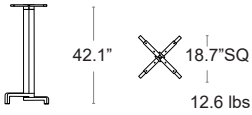

### Fiore

Cast Aluminum • E-Plated Powder Coat finish  
 • Specially Treated for High Salinity Environments

LIST: \$280 EA.    SELL: **\$185 EA.**

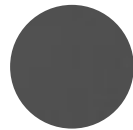

ANTRACITE  
53152

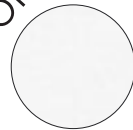

BIANCO  
53153

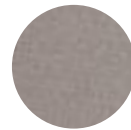

TORTORA  
53159

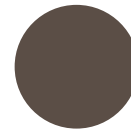

TABACCO  
53157

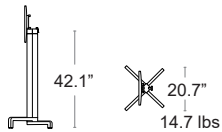

### Ibisco Tilt

Cast Aluminum • E-Plated Powder Coat finish  
 • Specially Treated for High Salinity Environments

LIST: \$330 EA.    SELL: **\$215 EA.**

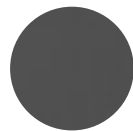

ANTRACITE  
54652

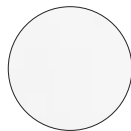

BIANCO  
54653



TORTORA  
54659



TABACCO  
54667

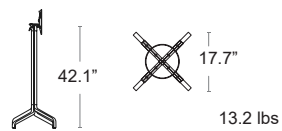

### Frasca Tilt

Cast Aluminum • E-Plated Powder Coat finish  
 • Specially Treated for High Salinity Environments

LIST: \$350 EA.    SELL: **\$230 EA.**



ANTRACITE  
53452

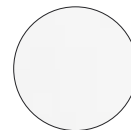

BIANCO  
53453



AGAVE  
53466



TORTORA  
53459



TABACCO  
53467



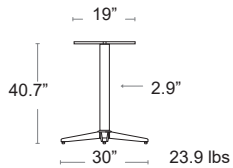
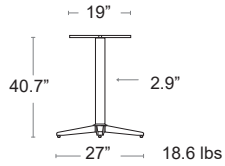

### Trail Bar Collection

Steel · E-plated Powder Coat finish · Award-winning self-stabilizing mechanical system

#### Trail 27

TRST27BKB-BLACK -BH

**LIST: \$290 EA.**

**SELL: \$190 EA.**

#### Trail 30

TRST30BKB-BLACK -BH

**LIST: \$340 EA.**

**SELL: \$220 EA.**



BLACK

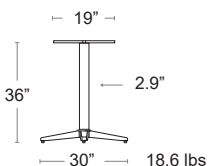
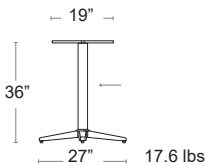

### Trail Counter Collection

#### Trail 27 Counter

Self Leveling Counter

TRST27BKC-BLACK -CH

**LIST: \$290 EA.**

**SELL: \$190 EA.**

#### Trail 30 Counter

Self Leveling Counter

TRST30BKC-BLACK -CH

**LIST: \$340 EA.**

**SELL: \$220 EA.**



BLACK





MADE IN CHINA

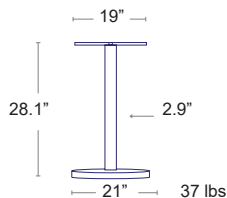

### Lunar

Steel · E-plated Powder Coat finish · Award-winning self-stabilizing mechanical system

**LIST: \$350 EA.    SELL: \$230 EA.**



BLACK  
LNST21BKB-BLACK -BH



MADE IN CHINA

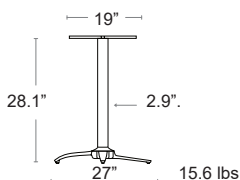

### Terrace Tilt

Steel · E-plated Powder Coat finish · Award-winning self-stabilizing mechanical system

**LIST: \$450 EA.    SELL: \$295 EA.**



BLACK  
TCAL27BKB-BLACK -BH



BAR HEIGHT BASES



YOUR OUTDOOR LIVING  
MADE IN ITALY

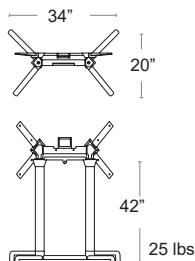

### Scudo Tilt Double

Cast Aluminum · E-Plated Powder Coat finish  
• Specially Treated for High Salinity Environments

**LIST: \$530 EA.    SELL: \$345 EA.**



ANTRACITE  
54452

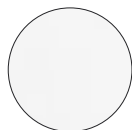

BIANCO  
54453

SPECIAL ORDER



TORTORA  
54459







## LOUNGE SEATING



**NARDI**  
YOUR OUTDOOR LIVING  
MADE IN ITALY





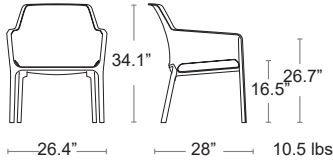

## Net Relax

Uniformly colored polypropylene & fiberglass • UV Protected  
See cushions Page 142

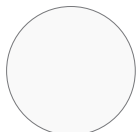
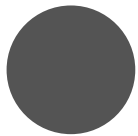
**LIST: \$230 EA.    SELL: \$150 EA.**

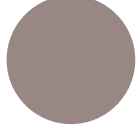

-  BIANCO  
40327.00
-  ANTRACITE  
40327.02
-  SALICE  
40327.04
-  TORTORA  
40327.10
-  SENAPE  
40327.56
-  CORALLO  
40327.75





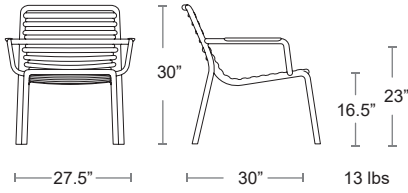

## Doga Relax

Uniformly colored polypropylene & fiberglass • UV Protected  
See cushions Page 142



**LIST: \$260 EA.    SELL: \$170 EA.**

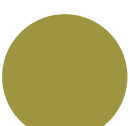

-  BIANCO  
40256.00
-  ANTRACITE  
40256.02
-  CAPPUCINO  
40256.14
-  MENTA  
40256.15
-  AGAVE  
40256.16
-  PERA  
40256.18
-  MARSALA  
40256.21
-  TABACCO  
40256.53



## Net Lounge

Uniformly colored polypropylene & fiberglass • UV Protected

**LIST: \$320 EA.    SELL: \$210 EA.**

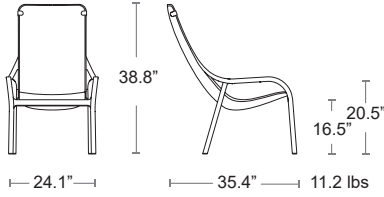

BIANCO  
40329.00



ANTRACITE  
40329.02

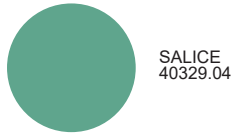

SALICE  
40329.04

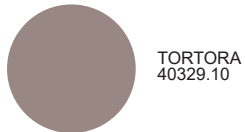

TORTORA  
40329.10

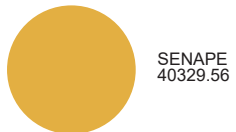

SENAPE  
40329.56

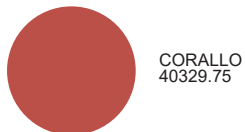

CORALLO  
40329.75



## Headrest Cushion

Adjustable straps • washable on delicate setting • 100% yarn dyed acrylic UV protected • Dirt repellent & Mold resistant

**LIST: \$80 EA.    SELL: \$50 EA.**

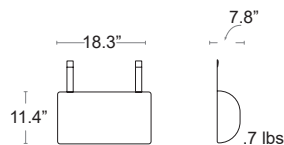

ROSA QUARZO  
36329.04.066

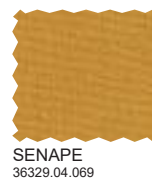

SENAPE  
36329.04.069



GRIGIO  
36329.04.136





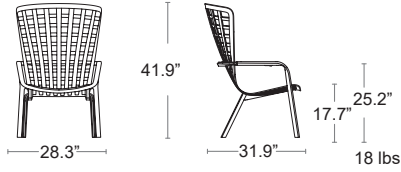

## Folio

Reclining armchair. Uniformly colored fibreglass polypropylene resins • UV Protected. • Matte finish • Non-slip replaceable feet.

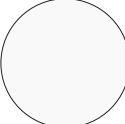
LIST: \$380 EA.    SELL: **\$250 EA.**



-  ANTRACITE  
40300.02
-  BIANCO  
40300.00
-  TORTORA  
40300.10
-  AGAVE  
40300.16
-  TABACCO  
40300.53

**Cushion**

Acrylic yarn dyed fabric with polyurethane foam & Velcro straps

**LIST: \$370 EA.**

**SELL: \$240 EA.**



LINO  
36300.152

ROSA  
SUNBRELLA  
36300.222

ARTIC  
SUNBRELLA  
36300.223

FELCE  
SUNBRELLA  
36300.224

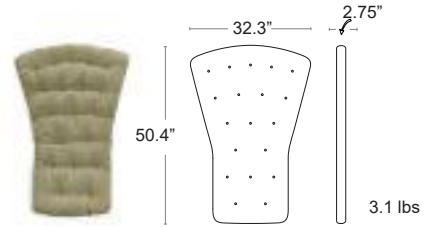

**LIST: \$280 EA.**

**SELL: \$185 EA.**



GRIGIO  
36300.163



**Headrest**

Acrylic yarn dyed fabric with polyurethane foam & Velcro straps

**LIST: \$90 EA.**

**SELL: \$60 EA.**



LINO  
36300.04.152

ROSA  
SUNBRELLA  
36300.04.222

ARTIC  
SUNBRELLA  
36300.04.223

FELCE  
SUNBRELLA  
36300.04.224

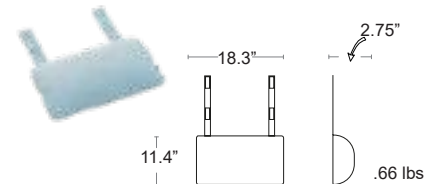

**LIST: \$80 EA.**

**SELL: \$45 EA.**



GRIGIO  
36300.04.163



35"



4 lbs

## Folio Accessories

### Rocker Kit

Uniformly colored fiberglass polypropylene resins • UV Protected

LIST: \$90 EA.

SELL: **\$60 EA.**

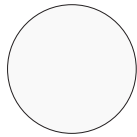

BIANCO  
40298.00



ANTRACITE  
40298.02



TORTORA  
40298.10

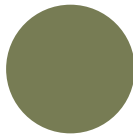

AGAVE  
40298.16



TABACCO  
40298.53

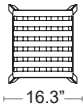

16.3"

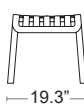

19.3"

17.3"

6 lbs

### Poggio Stool/Footrest

Uniformly colored fiberglass polypropylene resins  
• UV Protected • Matte finish

LIST: \$130 EA.

SELL: **\$85 EA.**

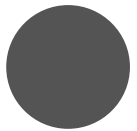

ANTRACITE  
40044.02

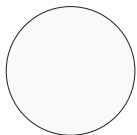

BIANCO  
40044.00



TORTORA  
40044.10



AGAVE  
40044.16



TABACCO  
40044.53







## Net Bench

Uniformly colored polypropylene & fiberglass • UV Protected  
See cushions Page 142

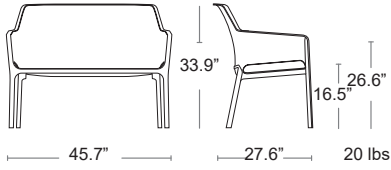

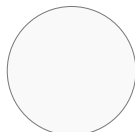
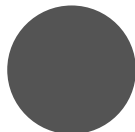
LIST: \$400 EA.    **SELL: \$260 EA.**



-  BIANCO  
40338.00
-  ANTRACITE  
40338.02
-  SALICE  
40338.04
-  TORTORA  
40338.10
-  SENAPE  
40338.56
-  CORALLO  
40338.75



Sunbrella 100% Solution dyed acrylic • Zippered removable cover • Washable  
 Custom Sunbrella Colors available for a 25% Surcharge • Expect 3-4 weeks for delivery

## Net Bench

No ties

\*C-BUM-NET-BENCH  
 + COLOR CODE

LIST: \$240 EA.

SELL: **\$155 EA.**

## Doga Relax

Velcro ties

\*C-BUM-DOGA-RELAX  
 + COLOR CODE

LIST: \$210 EA.

SELL: **\$135 EA.**

## Net Relax

No ties

\*C-BUM-NET-RELAX  
 + COLOR CODE

LIST: \$120 EA.

SELL: **\$80 EA.**



SPECTRUM  
 DAFFODIL  
 -48024



SPECTRUM  
 CILANTRO  
 -48022



SPECTRUM  
 EGGSHELL  
 -48018



CANVAS  
 GRANITE  
 -5402



SPECTRUM  
 CHERRY  
 -48096



SPECTRUM  
 CARBON  
 -48085



CANVAS  
 REGATTA  
 -5493



CANVAS  
 ARUBA  
 -5416



CANVAS  
 MELON  
 -5415

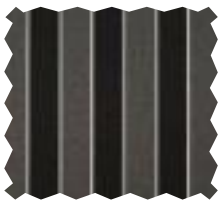

PEYTON  
 GRANITE  
 -56075

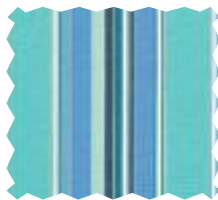

DOLCE  
 OASIS  
 -56001



DOLCE  
 MANGO  
 -56000



CABANA  
 CLASSIC  
 -58030

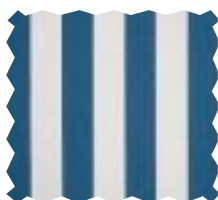

CABANA  
 REGATTA  
 -58029



MILANO  
 CHAR  
 -56079



## Lakeshore Lounge

High density polyethylene • Textured finish • Durable • UV Protected

LIST: \$690 EA.    **SELL: \$450 EA.**

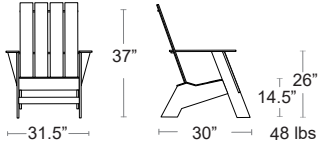

BSMAK-BLACK  
BSMAK-MINI-BLACK



BSMAK-WHITE  
BSMAK-MINI-WHITE



BSMAK-GREY  
BSMAK-MINI-GREY

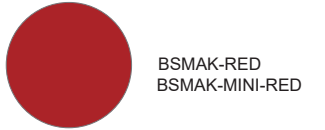

BSMAK-RED  
BSMAK-MINI-RED



## Lakeshore Lounge Mini

Kid sized version

LIST: \$460 EA.    **SELL: \$300 EA.**

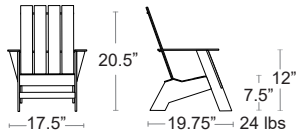

 SPECIAL ORDER



GOLDEN YELLOW



LIME GREEN



FOREST GREEN



COBALT

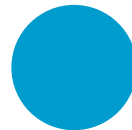

SKY BLUE

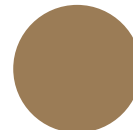

TAN LEATHER



CHOCOLATE





# Lakeshore Loveseat

High density polyethylene (HDPE) • Textured finish • Durable • UV protected



**LIST: \$1270 EA.    SELL: \$825 EA.**

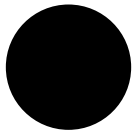
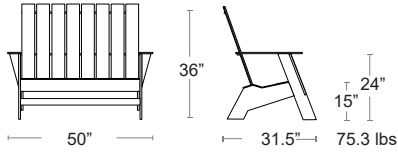

BSMAB-BLACK

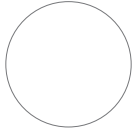

BSMAB-WHITE



BSMAB-GREY



BSMAB-RED



**SPECIAL ORDER**



GOLDEN YELLOW



LIME GREEN



FOREST GREEN

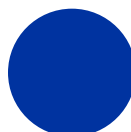

COBALT

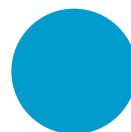

SKY BLUE



TAN LEATHER



CHOCOLATE



## Pine Beach Collection

LLDPE (linear low-density polyethylene) • Small drain hole • UV protected • 100% recyclable material • Solution dyed •

### Pine Beach Club Chair

PINEBEA/AC-ANT

**LIST: \$1050 EA.**

**SELL: \$685 EA.**

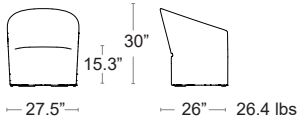

### Pine Beach Sofa

PINEBEA/SO-ANT

**LIST: \$2980 EA.**

**SELL: \$1940 EA.**

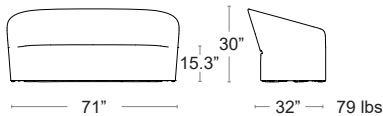

ANTRACITE



## Bronte Sectional Set Driftwood

Full Round Resin Wicker • Powder Coated Aluminum Frame

\*Throw pillows not included

**LIST: \$6500 EA.    SELL: \$4230 EA.**

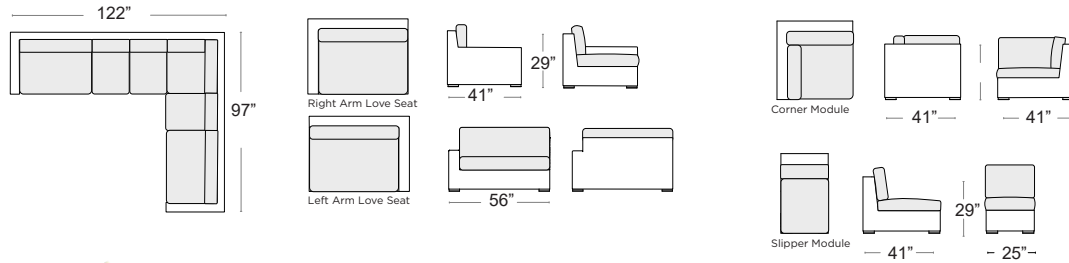

LOUNGE SEATING

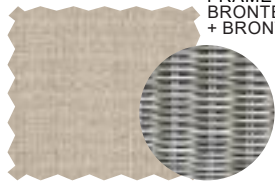

CUSHIONS - BLISS SAND  
FRAME - FULL ROUND RESIN WICKER DRIFTWOOD  
BRONTE SET-DRIFTWOOD  
+ BRONTE CUSH SET BLISS SA



WIDE RANGE OF FABRIC CHOICES AT NO ADDITIONAL COST · 3-4 WEEK LEAD TIME





# Bronte Sectional Set Charcoal

Full Round Resin Wicker • Powder Coated Aluminum Frame  
\*Throw pillows not included

**LIST: \$7220 EA.     SELL: \$4700 EA.**

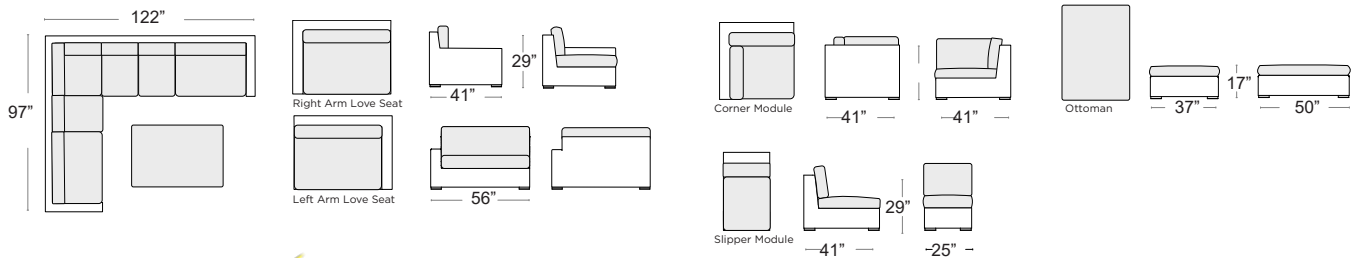

CUSHIONS - BLISS SMOKE  
FRAME - FULL ROUND RESIN WICKER CHARCOAL  
BRONTE SET-CHARCOAL  
+ BRONTE CUSH SET BLISS SM



WIDE RANGE OF FABRIC CHOICES AT NO ADDITIONAL COST · 3-4 WEEK LEAD TIME

LOUNGE SEATING



## Amalfi Collection

High density polyethylene (HDPE) • Textured finish • Durable • UV protected  
Cushions Sunbrella Cast Charcoal • Zippered for easy cleaning

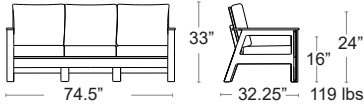

### Sofa

**LIST: \$3000 EA.**    **SELL: \$1950 EA.**

AMALFI-SOFA-FR



LOUNGE SEATING



CUSHIONS - SUNBRELLA CAST CHARCOAL 40483-001  
FRAME - CHARCOAL



WIDE RANGE OF FABRIC CHOICES AT NO ADDITIONAL  
COST • 3-4 WEEK LEAD TIME





### Loveseat

LIST: \$2000 EA.  
AMALFI-LOVE-FR

SELL: \$1300 EA.

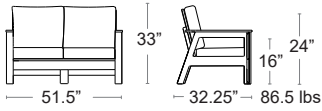

### Club Chair

LIST: \$1220 EA.  
AMALFI-CLUB-FR

SELL: \$795 EA.

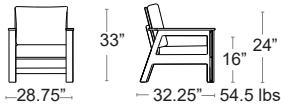

WIDE RANGE OF FABRIC CHOICES AT NO ADDITIONAL COST · 3-4 WEEK LEAD TIME



## Amalfi Modular Collection

High density polyethylene (HDPE) • Textured finish • Durable • UV protected • Includes Sunbrella cushions • Zippered for easy cleaning



AMALFI-LEFT-FR

Right or Left

LIST: \$2200 EA.    **SELL: \$1430 EA.**



AMALFI-RIGHT-FR

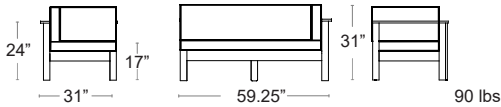

Armless

LIST: \$1070 EA.    **SELL: \$695 EA.**

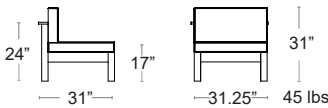

AMALFI-ARMLESS-FR

Corner

LIST: \$1440 EA.    **SELL: \$935 EA.**



AMALFI-CORNER-FR

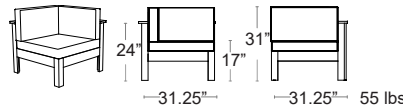

CUSHIONS - SUNBRELLA CAST CHARCOAL 40483-001  
FRAME - CHARCOAL



WIDE RANGE OF FABRIC CHOICES AT NO ADDITIONAL COST · 3-4 WEEK LEAD TIME

LOUNGE SEATING





MADE IN CHINA

sunbelievable

### City View Deep Seating Collection

- E-Plated Powder Coat finish • Welded Aluminum frame
- Includes Sunbelievable cushions • Zippered for easy cleaning

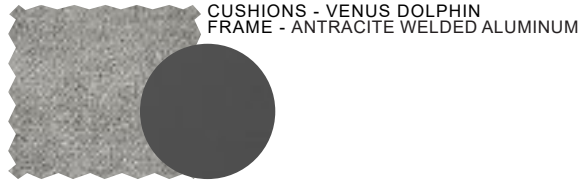

#### Sofa

LIST: \$2600 EA.    SELL: **\$1690 EA.**

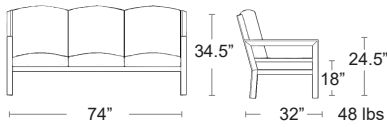

CITYVIEW-581

#### Love Seat

LIST: \$1800 EA.    SELL: **\$1170 EA.**

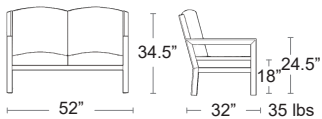

CITYVIEW-582



sunbelievable

### City View Modular Collection

#### Swivel Armchair

LIST: \$1460 EA.    **SELL: \$950 EA.**



CITYVIEW-586

#### Recliner High Back Armchair

LIST: \$1300 EA.    **SELL: \$845 EA.**

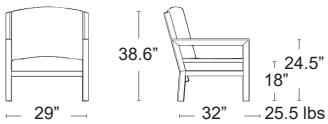

CITYVIEW-511

#### Club Chair

LIST: \$1180 EA.    **SELL: \$770 EA.**

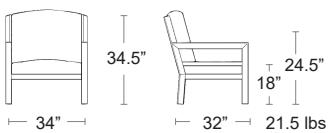

CITYVIEW-583

LOUNGE SEATING



sunbelievable

### Long Sofa

LIST: \$3400 EA.

SELL: \$2210 EA.

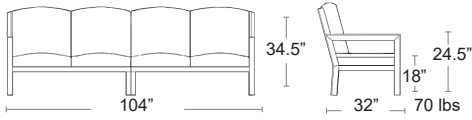

CITYVIEW-02R+02L

### Right or Left

LIST: \$1700 EA.

SELL: \$1105 EA.

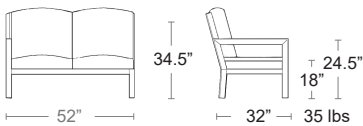

CITYVIEW-02L



CITYVIEW-02R



sunbelievable

# City View Modular Collection

## Corner

LIST: \$1800 EA.

SELL: \$1170 EA.

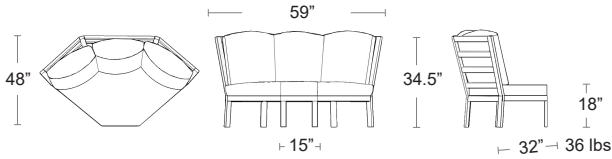

CITYVIEW-00C



## Double Armless

LIST: \$1600 EA.

SELL: \$1040 EA.

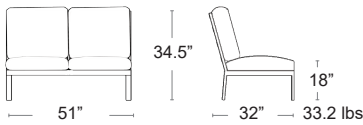

CITYVIEW-02A



## Armless

LIST: \$900 EA.

SELL: \$585 EA.

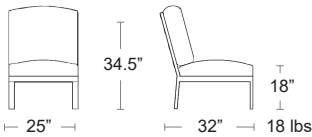

CITYVIEW-00A



## Ottoman

LIST: \$500 EA.

SELL: \$325 EA.

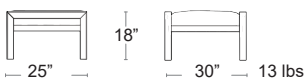

CITYVIEW-508



LOUNGE SEATING



## Maximo Modular Deep Seating Collection

Uniformly colored fiberglass & polypropylene • UV Protected • Recyclable  
The Nardi Regeneration industrial program is creating a line of outdoor furniture specifically dedicated to regenerated plastic products, made of post-industrial & post-consumer polypropylene, which can in turn be recycled  
Create your own unique sectional set.

### Corner Module

**LIST: \$1760 EA.**  
**SELL: \$1145 EA.**

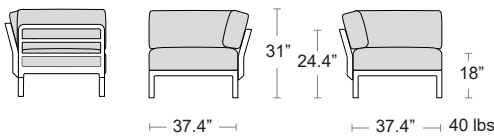

40184.+ FRAME & FABRIC  
COLOR CODES

### Armless Module

**LIST: \$1320 EA.**  
**SELL: \$860 EA.**

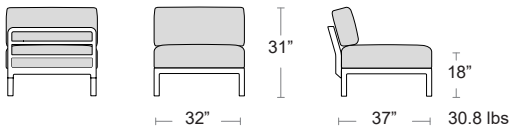

40183.+ FRAME & FABRIC  
COLOR CODES

### Pouf/Ottoman

**LIST: \$960 EA.**  
**SELL: \$625 EA.**

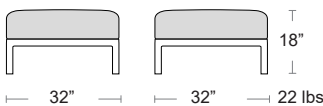

40179.+ FRAME & FABRIC  
COLOR CODES

## Maximo 5 Sofa Set

Uniformly colored fiberglass & polypropylene • UV Protected • Recyclable  
The Nardi Regeneration industrial program is creating a line of outdoor furniture specifically dedicated to regenerated plastic products, made of post-industrial & post-consumer polypropylene, which can in turn be recycled

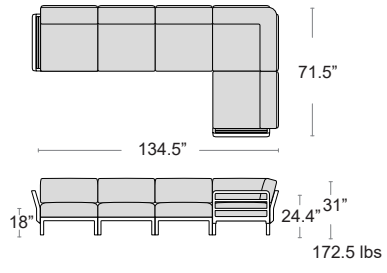

**LIST: \$7000 EA.    SELL: \$4550 EA.**

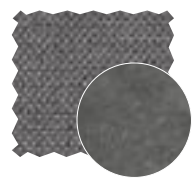

CUSHIONS - LAVA 215  
FRAME - BASALTO.25  
40180.25.215

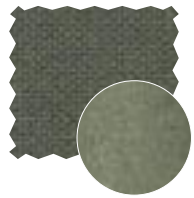

CUSHIONS - TIMO 217  
FRAME - CACTUS 27  
40180.27.217

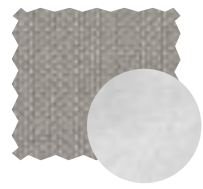

CUSHIONS - PERLA 213  
FRAME - GESSO 29  
40180.29.213

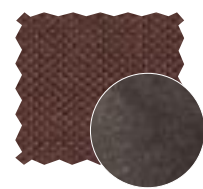

CUSHIONS - CANNELLA 219  
FRAME - TERRA 44  
40180.44.219



LOUNGE SEATING

Maximo Upholstery & Frame Color Combinations

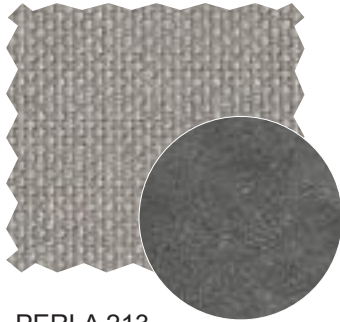

PERLA 213  
BASALTO 25

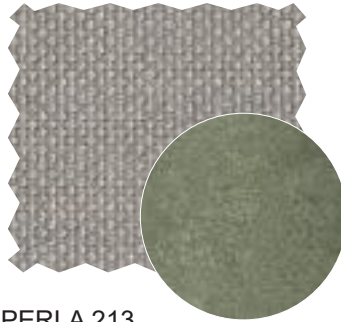

PERLA 213  
CACTUS 27

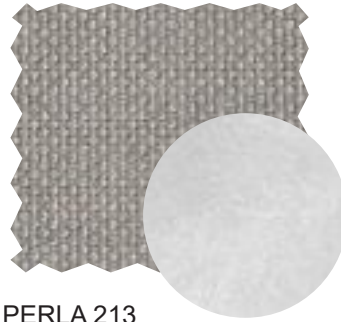

PERLA 213  
GESSO 29

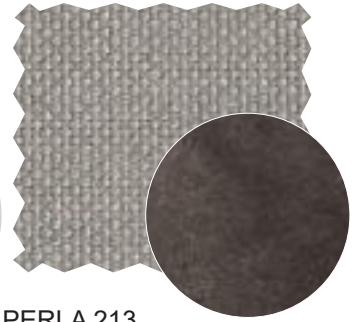

PERLA 213  
TERRA 44

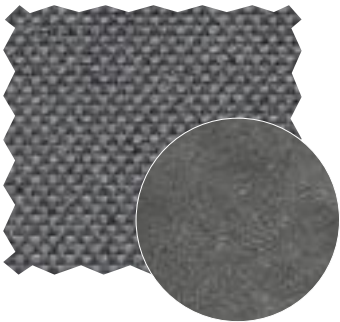

LAVA 215  
BASALTO 25

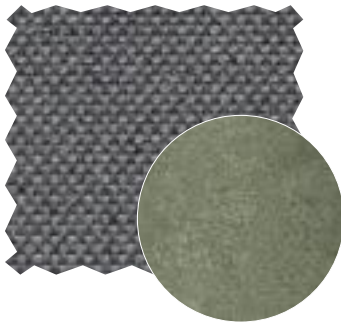

LAVA 215  
CACTUS 27

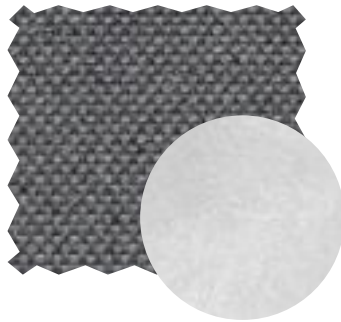

LAVA 215  
GESSO 29

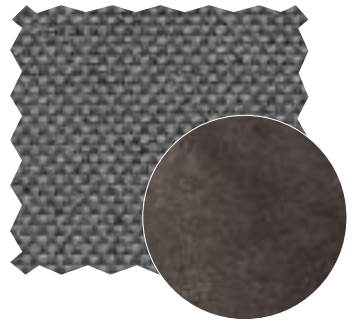

LAVA 215  
TERRA 44

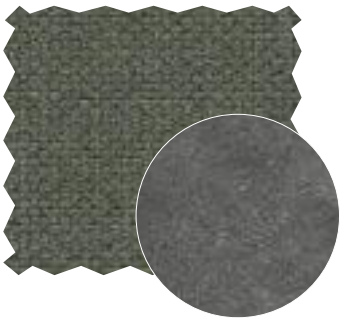

TIMO 217  
BASALTO 25

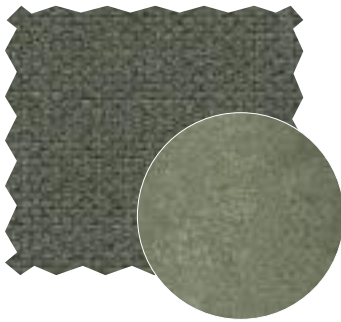

TIMO 217  
CACTUS 27



TIMO 217  
GESSO 29

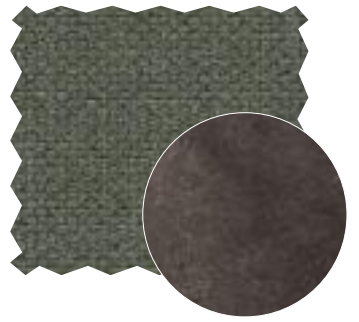

TIMO 217  
TERRA 44

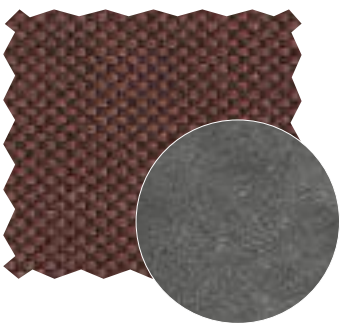

CANNELLA 219  
BASALTO 25

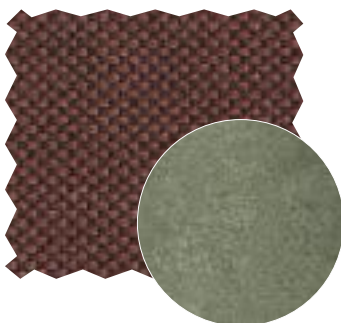

CANNELLA 219  
CACTUS 27

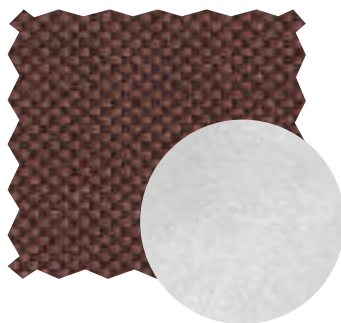

CANNELLA 219  
GESSO 29

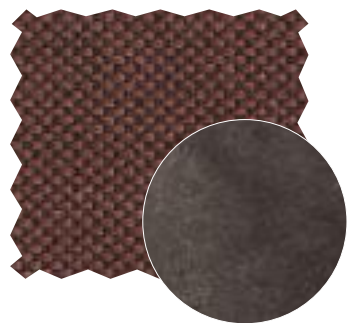

CANNELLA 219  
TERRA 44

## Maximo Tables

Uniformly colored fiberglass & polypropylene • UV Protected • Recyclable  
The Nardi Regeneration industrial program is creating a line of outdoor furniture specifically dedicated to regenerated plastic products, made of post-industrial & post-consumer polypropylene, which can in turn be recycled



### Coffee Table

40178.+ COLOR CODE

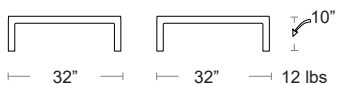

**LIST: \$430 EA.**  
**SELL: \$280 EA.**

### Maximo 60 Maxi

40172 + COLOR CODE

### Maximo 60 Mini

40170 + COLOR CODE

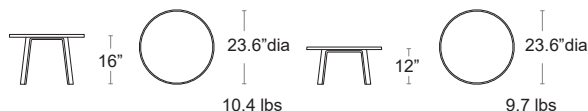

**LIST: \$310 EA.**  
**SELL: \$200 EA.**

### Maximo 70 Maxi

\*40173 + COLOR CODE

### Maximo 70 Mini

40171 + COLOR CODE

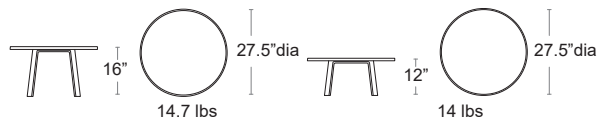

**LIST: \$360 EA.**  
**SELL: \$235 EA.**

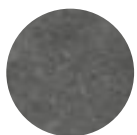

BASALTO  
.25

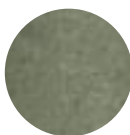

CACTUS  
.27

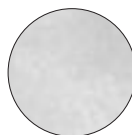

GESSO  
.29



TERRA  
.44

Maximo Accesories

Maximo Table 33

40177\*+ COLOR CODE  
**LIST: \$90 EA.**  
**SELL: \$60 EA.**

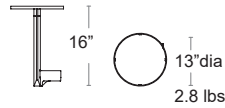

Curved Arm/Back

**LIST: \$120 EA.**  
**SELL: \$80 EA.**

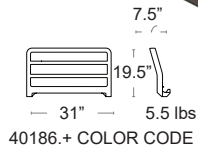
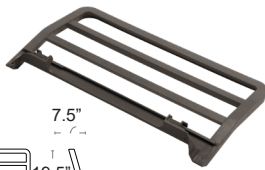

40186.+ COLOR CODE

Straight Arm/Back

**LIST: \$120 EA.**  
**SELL: \$80 EA.**

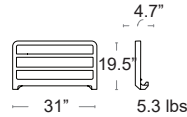
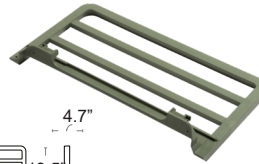

40185.+ COLOR CODE

Shelf Module

**LIST: \$120 EA.**  
**SELL: \$80 EA.**

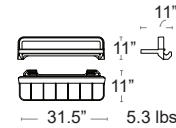

40188.+ COLOR CODE



Maximo Pillows

Bolster Pillow 24"x16"

36180.02 + COLOR CODE  
**LIST: \$150 EA.**  
**SELL: \$100 EA.**



LAVA  
.216



TIMO  
.218

Bolster Pillow 28"x12"

36180.03 + COLOR CODE  
**LIST: \$150 EA.**  
**SELL: \$100 EA.**



CANNELLA  
.220



PERLA  
.214

Toss Pillow 19.5"x19.5"

36180.01+COLOR CO17  
**LIST: \$170 EA.**  
**SELL: \$110 EA.**



Sunbrella 100% Solution dyed acrylic • Zippered removable cover • Washable  
 Custom Sunbrella colors available for a 25% Surcharge • Expect 3-4 weeks for delivery

## Toss

18" x 18" x 7" .5 lbs

\*C-BUM-TOSS + COLOR CODE

## Bolster

20" x 10" x 7" .5 lbs

\*C-BUM-BOLSTER + COLOR CODE

**LIST: \$70 EA.**

**SELL: \$45 EA.**



SPECTRUM EGGSHELL  
-48018



SPECTRUM CILANTRO  
-48022



SPECTRUM DAFFODIL  
-48024



SPECTRUM CARBON  
-48085



SPECTRUM CHERRY  
-48096



CANVAS REGATTA  
-5493



CANVAS ARUBA  
-5416



CANVAS GRANITE  
-5402



CANVAS MELON  
-5415



DOLCE MANGO  
-56000



PEYTON GRANITE  
-56075



CABANA REGATTA  
-58029



DOLCE OASIS  
-56001







MILANO CHAR  
-56079



CABANA CLASSIC  
-58030



Enhance patios, rooftops, & outdoor seating areas with custom commercial-grade cushions made with Sunbrella® performance fabric. Durable, professional seating solutions available for restaurants, hotels, resorts, offices & more.

-  Built for High Traffic • withstands daily use in busy commercial environments
-  UV-Protected & Fade-Resistant • maintains a polished, professional look, season after season
-  Weather-Resistant & Easy to Maintain • designed to handle spills, rain, & outdoor exposure
-  Custom Branding Options - wide range of fabrics, colors, & styles to align with your brand identity

Deliver comfort, style, & long-lasting quality to your guests, clients, & staff.

 For fabric samples, bulk pricing, & custom solutions contact: [samplerequest@bumoutdoor.ca](mailto:samplerequest@bumoutdoor.ca)





# Bum Relax Single Sunlounger

E-Plated Powder Coat finish • Welded Aluminum frame • Head & foot 4 position adjustable • Includes Sunbrella cushions • Zippered removable cover • Washable



LIST: \$1800 EA.    **SELL: \$1170 EA.**

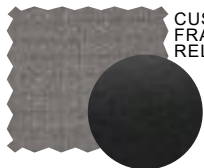
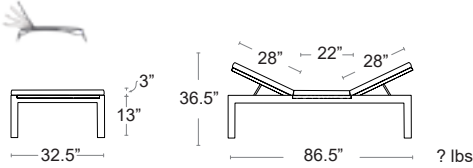

CUSHIONS - BLISS SMOKE  
FRAME - BLACK  
RELAX.SINGLE.BK



CUSHIONS - BLISS SMOKE  
FRAME - WHITE  
RELAX.SINGLE.WH



WIDE RANGE OF FABRIC CHOICES AT NO ADDITIONAL COST • 3-4 WEEK LEAD TIME

SUNLOUNGERS





# Bum Relax Double Sunlounger

E-Plated Powder Coat finish • Welded Aluminum frame • 1.5" Umbrella hole • Head & foot 4 position adjustable • Includes Sunbrella cushions • Zippered removable cover • Washable

LIST: \$2800 EA.    **SELL: \$1820 EA.**

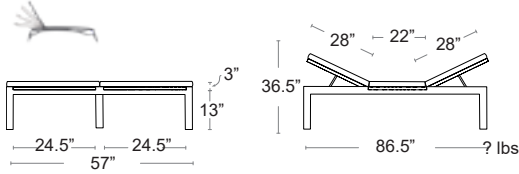

\*UMBRELLA & BASE SOLD SEPARATELY\*

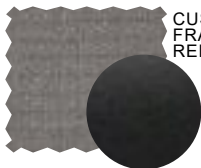

CUSHIONS - BLISS SMOKE  
FRAME - BLACK  
RELAX.DOUBLE.BK



CUSHIONS - BLISS SMOKE  
FRAME - WHITE  
RELAX.DOUBLE.WH



WIDE RANGE OF FABRIC CHOICES AT NO ADDITIONAL COST • 3-4 WEEK LEAD TIME





# LOUNGE TABLES



**NARDI**  
YOUR OUTDOOR LIVING  
MADE IN ITALY

## Pop

Uniformly colored fiberglass & polypropylene • UV Protected • Recyclable •  
Removeable shelf included



**LIST: \$120 EA.    SELL: \$78 EA.**

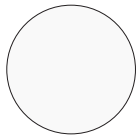
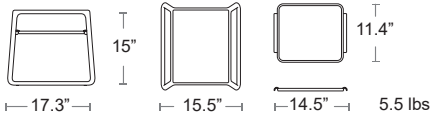

BIANCO  
40048.00

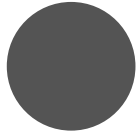

ANTRACITE  
40048.02



TORTORA  
40048.10





Net 40

Uniformly colored fiberglass & polypropylene • UV Protected • Recyclable

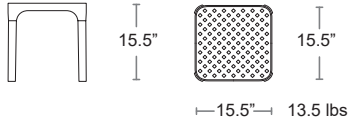

LIST: \$90 EA.      SELL: **\$60 EA.**

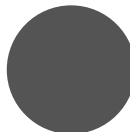

-  BIANCO  
40062.00
-  ANTRACITE  
40062.02
-  SALICE  
40062.04
-  TORTORA  
40062.10
-  MENTA  
40062.15
-  CORDA  
40062.24
-  TABACCO  
40062.53
-  SENAPE  
40062.56
-  CORALLO  
40062.75



# Net 100





Uniformly colored fiberglass & polypropylene • UV Protected • Recyclable

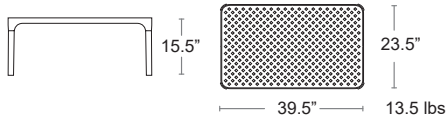

LIST: \$210 EA.

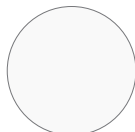
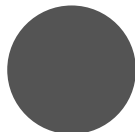
SELL: **\$135 EA.**



-  BIANCO  
40064.00
-  ANTRACITE  
40064.02
-  SALICE  
40064.04
-  TORTORA  
40064.10
-  SENAPE  
40064.56
-  CORALLO  
40064.75

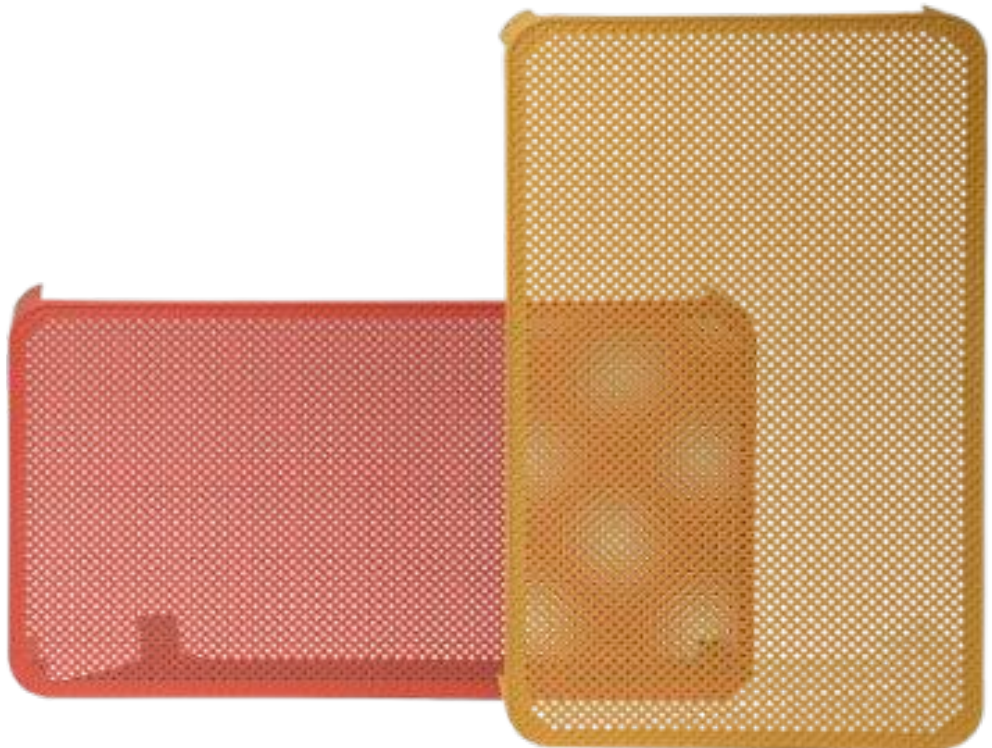

## Doga

Uniformly colored fiberglass & polypropylene • UV Protected • Recyclable

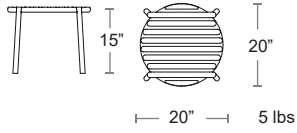

LIST: \$130 EA.    SELL: **\$85 EA.**



-  BIANCO  
40042.00
-  ANTRACITE  
40042.02
-  CAPPUCINO  
40042.14
-  MENTA  
40042.15
-  AGAVE  
40042.16
-  PERA  
40042.18
-  MARSALA  
40042.21
-  TABACCO  
40042.53





## Cero

LLDPE (linear low density polyethylene • UV Protected • Recyclable • Solution Dyed • Durable • Stool or Side Table

**LIST: \$470 EA.    **SELL: \$305 EA.****

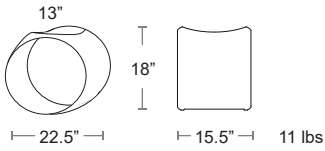

ANTRACITE  
CERO-ANT

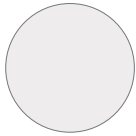

WHITE  
CERO-IWH



LIGHT GREY  
CERO-GG



LIGHT YELLOW  
CERO-GS



RED  
CERO-RO



TORTORA  
CERO-TO

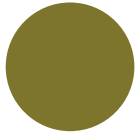

OLIVE GREEN  
CERO-VOC

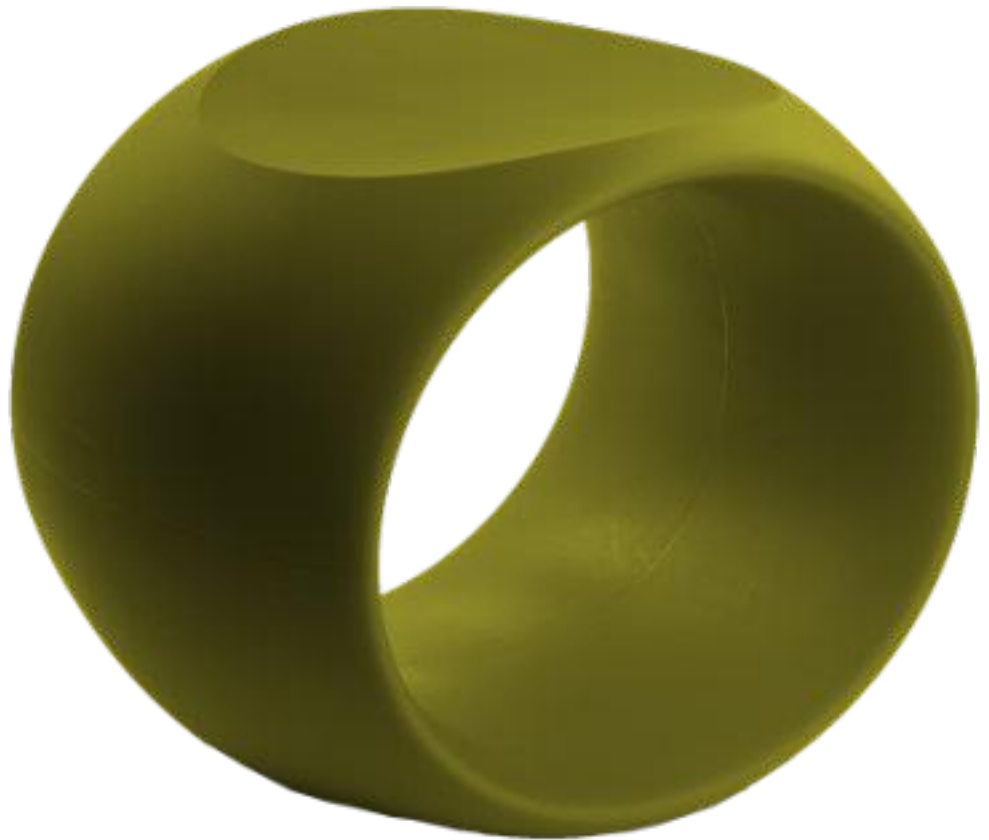

## Juju

LLDPE (linear low density polyethylene • UV Protected • Recyclable • Solution Dyed • Durable • Stool or Side Table



**LIST: \$560 EA.    SELL: \$365 EA.**

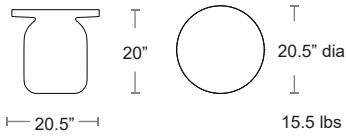

ANTRACITE  
JUJU-ANT

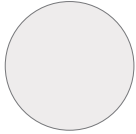

WHITE  
JUJU-IWH



LIGHT GREY  
JUJU-GG



LIGHT YELLOW  
JUJU-GS



RED  
JUJU-RO



TORTORA  
JUJU-TO



OLIVE GREEN  
JUJU-VOC





## City View Collection

Welded Aluminum frame • E-Plated Powder Coat finish

### Side Table

CITYVIEW-20SQ

**LIST: \$320 EA.**

**SELL: \$210 EA.**

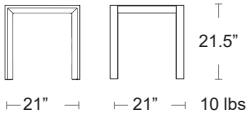

### Coffee Table

CITYVIEW-2442

**LIST: \$560 EA.**

**SELL: \$365 EA.**

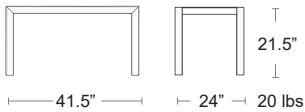

### Console Table

CITYVIEW-2050T

**LIST: \$670 EA.**

**SELL: \$435 EA.**

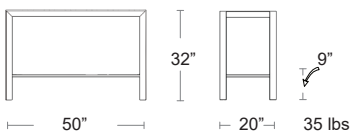

ANTRACITE WELDED ALUMINUM



# Amalfi/Lakeshore Collection

High density polyethylene (HDPE) • Durable • UV protected

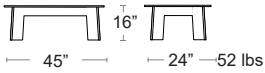
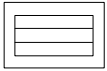

Side Table  
LIST: \$580 EA.  
SELL: \$380 EA.

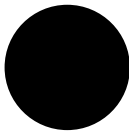

Side Table • BSMOS-BLACK  
Coffee Table • BSMRC-BLACK

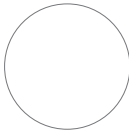

Side Table • BSMOS-WHITE  
Coffee Table • BSMRC-WHITE



Side Table • BSMOS-GREY  
Coffee Table • BSMRC-GREY



Side Table • BSMOS-RED  
Coffee Table • BSMRC-RED

Coffee Table  
LIST: \$770 EA.  
SELL: \$500 EA.

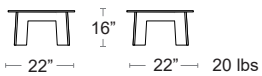

LOUNGE TABLES



SPECIAL ORDER



GOLDEN YELLOW



LIME GREEN



FOREST GREEN



COBALT

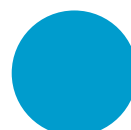

SKY BLUE



TAN LEATHER



CHOCOLATE



# Jakarta Teak Collection

Solid natural Teak construction

## Cube Side Table/Stool

TEAK.CUBE

**LIST: \$700 EA.**

**SELL: \$455 EA.**

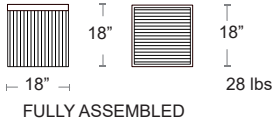

## Side Table

TEAK.SIDE

**LIST: \$730 EA.**

**SELL: \$475 EA.**

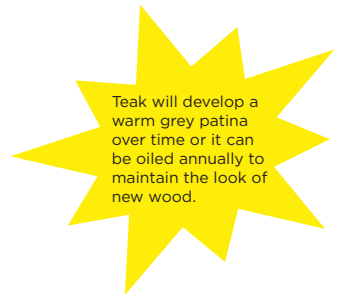
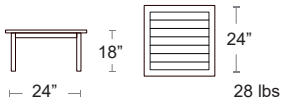

Teak will develop a warm grey patina over time or it can be oiled annually to maintain the look of new wood.

## Coffee Table

TEAK.COFFEE

**LIST: \$1070 EA.**

**SELL: \$695 EA.**

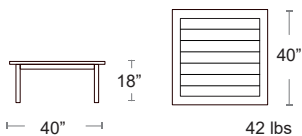

TEAK







# COMPLEMENTS



**IF YOU DON'T SEE WHAT YOU WANT,  
JUST ASK.  
WE COLLABORATE  
WITH FACTORIES WORLDWIDE  
TO BRING YOUR VISION TO LIFE**



## Jakarta Teak Collection

Solid natural Teak construction

### Bench

TEAK-BENCH-6'

LIST: \$1120 EA.

SELL: \$730 EA.

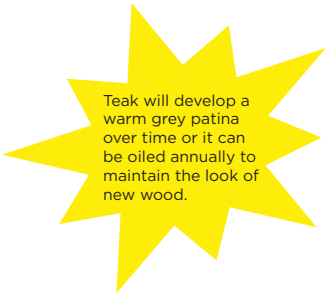
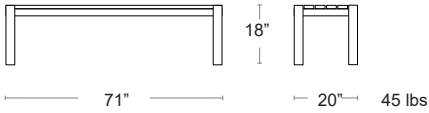

Teak will develop a warm grey patina over time or it can be oiled annually to maintain the look of new wood.

### Bench with Back

TEAK-BENCHwBACK-6'

LIST: \$1700 EA.

SELL: \$1105 EA.

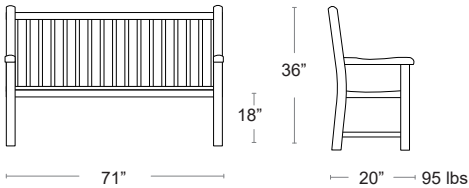



## Skyline Cushion Box

All-Weather polyethylene wicker double fish bone weave • Hand woven • Fully welded aluminum frame • E-Plated Powder Coat finish

LIST: \$2160 EA.

SELL: **\$1400 EA.**

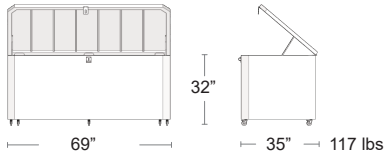

\*CUSHIONS SOLD SEPARATELY\*



POLYETHYLENE  
ALL-WEATHER WICKER  
SKY-BOX 2.0

COMPLEMENTS



## Towel Stand with Shelf

High density polyethylene (HDPE) • Very high impact resistance • Textured finish • UV protected • Available in 11 Colors 4 week delivery

**LIST: \$2350 EA.    SELL: \$1525 EA.**

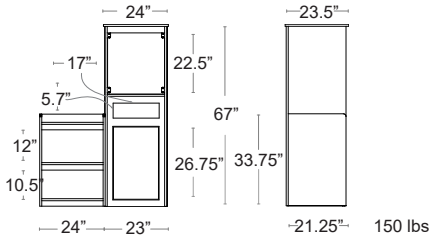

TOWEL STAND-SHELF

 **SPECIAL ORDER**  
4 Weeks

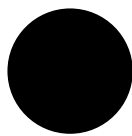

BLACK

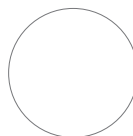

WHITE



GREY

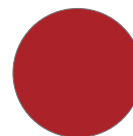

RED



GOLDEN  
YELLOW



LIME  
GREEN



FOREST  
GREEN

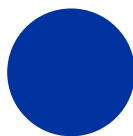

COBALT

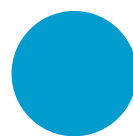

SKY BLUE

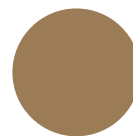

TAN  
LEATHER



CHOCOLATE



## Single Litter Bin

High density polyethylene (HDPE) • Very high impact resistance •  
Textured finish • UV protected

LIST: \$1970 EA.

SELL: **\$1280 EA.**

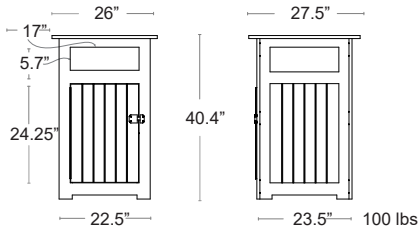

1.GARBAGE



**SPECIAL ORDER**  
4 Weeks

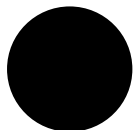

BLACK

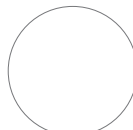

WHITE



GREY



RED



GOLDEN  
YELLOW



LIME  
GREEN



FOREST  
GREEN



COBALT

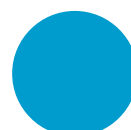

SKY BLUE



TAN  
LEATHER



CHOCOLATE



## Bartolomeo Collection

Modular elements • Easy to move • Durable polyethylene construction  
Use alone or paired with other components to create what you need



### Bartolomeo Bar Display Black

LIST: \$2360 EA.  
SELL: **\$1535 EA.**

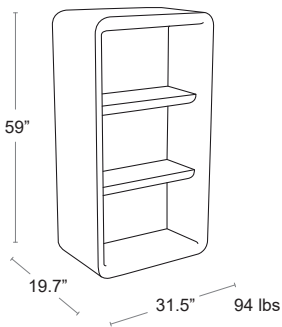

### Bartolomeo Bar Display Neutral

With 1 White light  
LIST: \$2680 EA.  
SELL: **\$1740 EA.**



BLACK  
6289-87

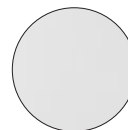

WHITE  
6289-98



183



## Bartolomeo Corner Black

With Wheels

LIST: \$2100 EA.

SELL: **\$1365 EA.**



BLACK  
6278-87

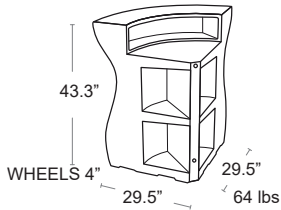

Double Corner



Bar & Corner



## Bartolomeo Corner Neutral

With 1 White light & Wheels

LIST: \$2310 EA.

SELL: **\$1500 EA.**

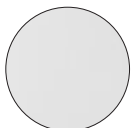

WHITE  
6278-98



# Bartolomeo Modular Bar Collection



## Bartolomeo Bar Black

With 1 Shelf & Wheels

LIST: \$4600 EA.    SELL: **\$2990 EA.**

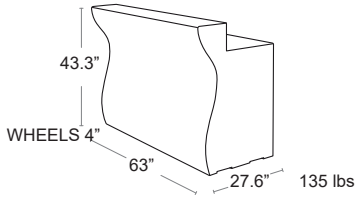
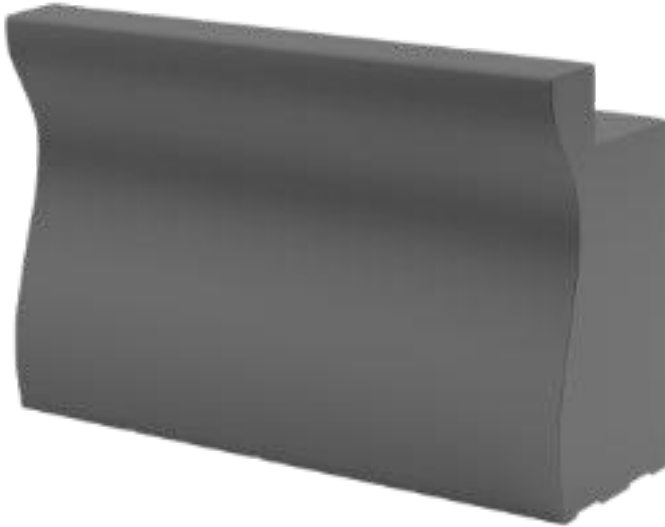

BLACK  
6277-87

## Bartolomeo Bar Neutral

With 2 White lights, 1 Shelf & Wheels

LIST: \$5040 EA.    SELL: **\$3280 EA.**

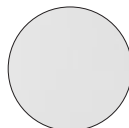

WHITE  
6277-98



## Frozen Catering Counter

Durable polyethylene construction • Removable countertop • .  
Wheels Included

## Frozen Catering Counter Black

Half top & Wheels

**LIST: \$3260 EA.    SELL: \$2120 EA.**



BLACK  
6413-87

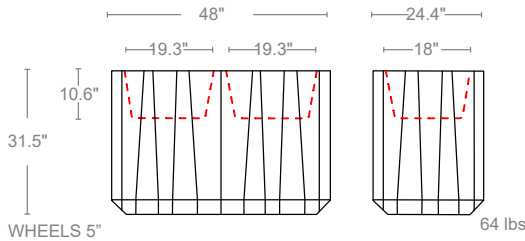

## Frozen Catering Counter Neutral

2 White lights • Half top & Wheels

**LIST: \$3720 EA.    SELL: \$2420 EA.**

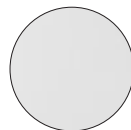

WHITE  
6413-98

**SERRALUNGA**  
MADE IN ITALY

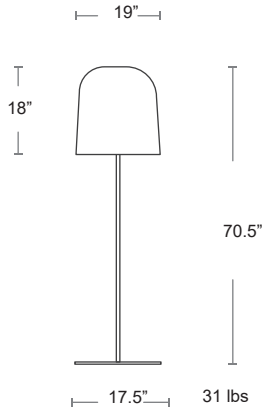

## Floor Lamps

### Odette

Solution dyed rotational molded shade • UV protected • Durable • Recyclable • Lacquered steel frame

**LIST: \$2360 EA.    SELL: \$1535 EA.**



ODETTE/LR

**SERRALUNGA**  
MADE IN ITALY

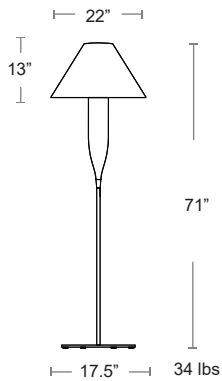

### Bonheur

White matte polymer shade • Durable wide polyethylene base

**LIST: \$2570 EA.    SELL: \$1670 EA.**



BONHEUR-P

**SERRALUNGA**  
MADE IN ITALY

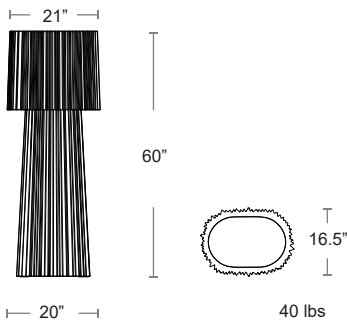

### Ruffle

LLDPE (linear low-density polyethylene) • Rotational molded • UV Protected • Durable • Recyclable • Wireless LED system • Remote included

**LIST: \$5200 EA.    SELL: \$3380 EA.**



RUFFLE-P/LD

WHITE

## Floor Lamps

Rotational molded • Lacquered surface specially engraved  
• UV Protected • Remote included

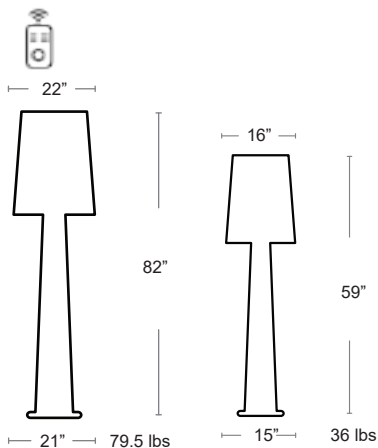

**Lady Jane**  
**LIST: \$7080 EA.**  
**SELL: \$4600 EA.**

### Miss Jane

A scaled down version of the Lady Jane  
**LIST: \$4720 EA.**  
**SELL: \$3070 EA.**



ANTRACITE  
LADY JANE LAMP-LAN  
MISS JANE LAMP-LAN



BLACK  
LADY JANE LAMP-LBK  
MISS JANE LAMP-LBK



RED  
LADY JANE LAMP-LRO  
MISS JANE LAMP-LRO

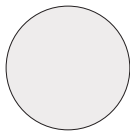

WHITE  
LADY JANE LAMP-LWH  
MISS JANE LAMP-LWH



**Lady Mary**  
**LIST: \$7100 EA.**  
**SELL: \$4615 EA.**

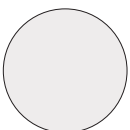
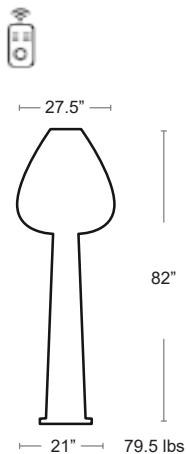

LADY MARY LAMP-LWH



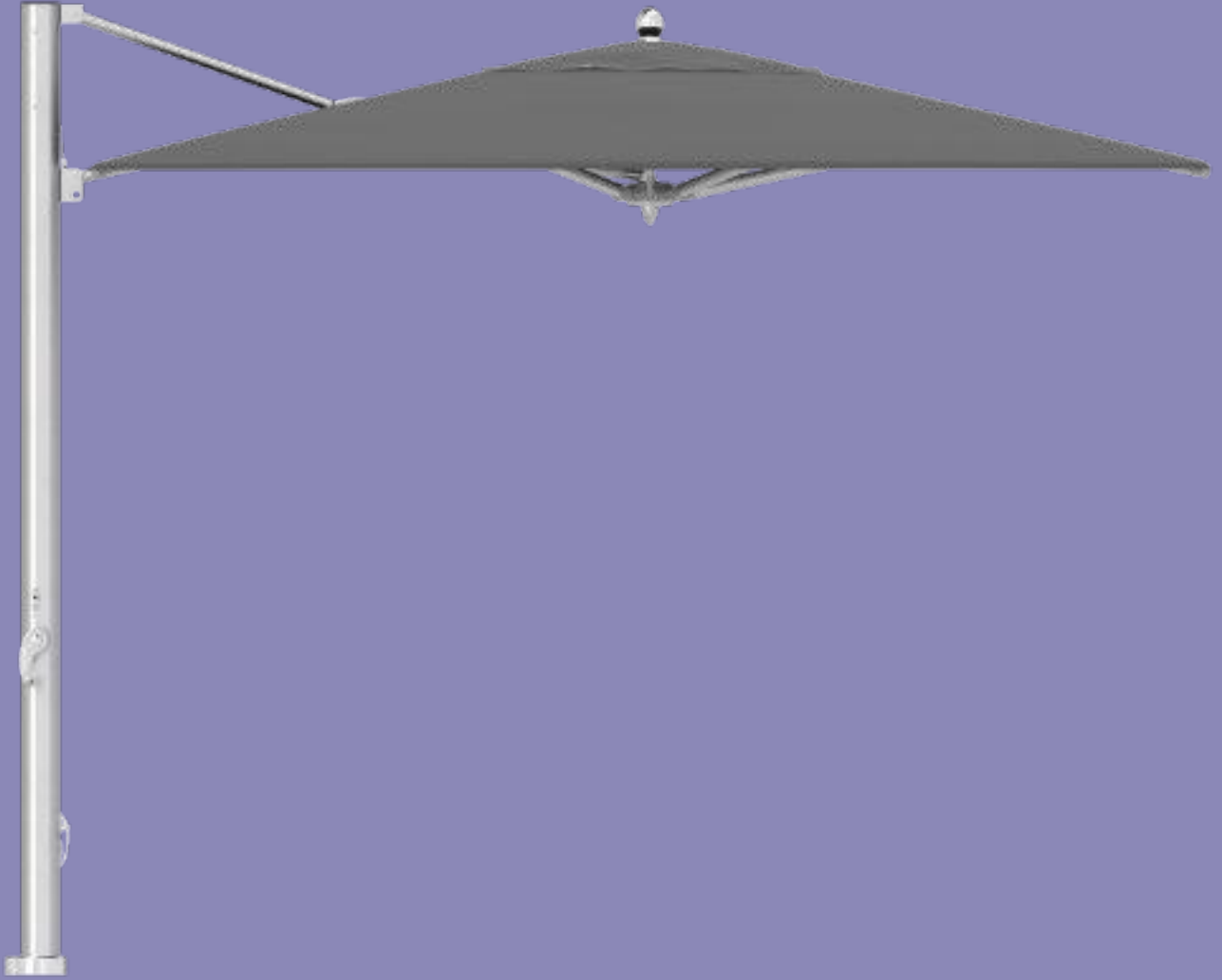

**SHADE**





## Oasis 9' Octagon

Recasens Recacril 9 oz Marine Grade Solution Dyed Acrylic Fabric • Single wind vent • Brushed aluminum frame • 2 piece center pole • Stainless steel hardware • Manual lift with pin

**LIST: \$700 EA.    SELL: \$455 EA.**

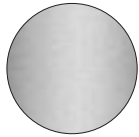
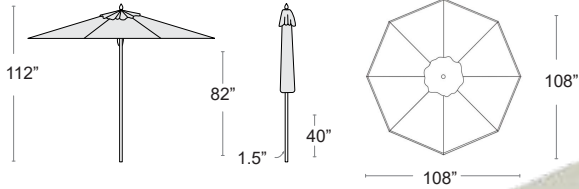

FRAME  
BRUSHED ALUMINUM



DENIM BLUE  
OASIS-9'OCT-BLUE



DARK GREY  
OASIS-9'OCT-DARK.GREY



VERMILION  
OASIS-9'OCT-RED

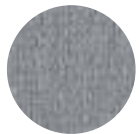

TITANIUM  
OASIS-9'OCT-TITAN.GREY



SEASHELL  
OASIS-9'OCT-WHITE



**SPECIAL ORDER**

**CUSTOM COLOR FABRIC**

OASIS-9'OCT-FRAME + COLOR CODE

info@bumoutdoor.ca for options

**LIST: \$1250 EA.    SELL: \$815 EA.**



## Oasis 7.5' Square

Recasens Recacril 9 oz Marine Grade Solution Dyed Acrylic Fabric • Single wind vent • Brushed aluminum frame • 2 piece center pole • Stainless steel hardware • Manual lift with pin

**LIST: \$830 EA.    SELL: \$540 EA.**

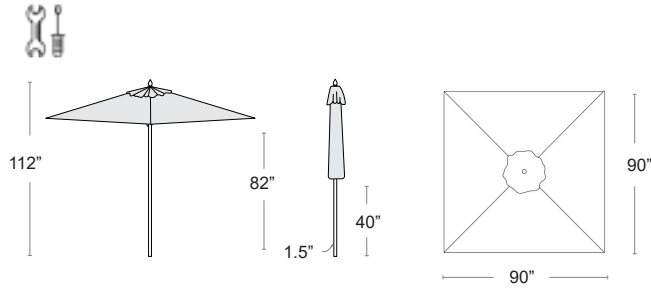

FRAME  
BRUSHED ALUMINUM



DENIM BLUE  
OASIS-7.5'SQ-BLUE



DARK GREY  
OASIS-7.5'SQ-DARK.GREY



VERMILION  
OASIS-7.5'SQ-RED

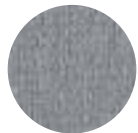

TITANIUM  
OASIS-7.5'SQ-TITAN.GREY



SEASHELL  
OASIS-7.5'SQ-WHITE



**SPECIAL ORDER**

### CUSTOM COLOR FABRIC

OASIS-7.5'SQ-FRAME + COLOR CODE

info@bumoutdoor.ca for options

**LIST: \$1350 EA.    SELL: \$880 EA.**



## Oasis 6' x 9' Rectangle

Recasens Recacril 9 oz Marine Grade Solution Dyed Acrylic Fabric • Single wind vent • Brushed aluminum frame • 2 piece center pole • Stainless steel hardware • Manual lift with pin

**LIST: \$940 EA.     SELL: \$610 EA.**

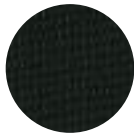
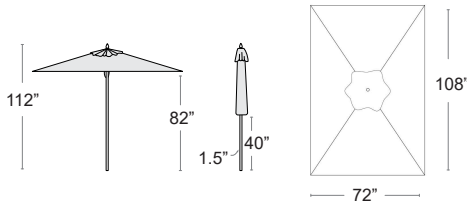

DARK GREY  
OASIS-6'x9'-DARK.GREY



VERMILION  
OASIS-6'x9'-RED



SEASHELL  
OASIS-6'x9'-WHITE



**SPECIAL ORDER**

**CUSTOM COLOR FABRIC**

OASIS-6' X 9'-FRAME + FABRIC CODE

info@bumoutdoor.ca for options

**LIST: \$1520 EA.     SELL: \$990 EA.**

SHADE



### Bay Master 6.5' & 8' Square

Sunbrella Furniture Grade fabric • Single wind vent • Market cut canopy • Polished aluminum frame • Center pole & stem • Manual lift with easy grip handle • Replaceable parts

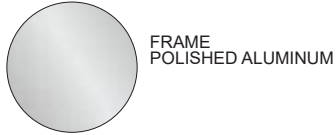

FRAME  
POLISHED ALUMINUM



GRANITE



JOCKEY RED

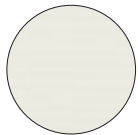

NATURAL



BLACK



TUSCAN



MACAW



SAPPHIRE



COAL

### Bay Master 6.5'SQ

BM6.5SQ + COLOR

**LIST: \$1170 EA.**

**SELL: \$760 EA.**

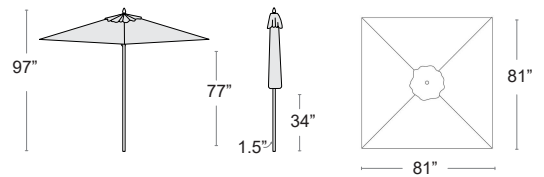

### Bay Master 8' SQ

BM8.0SQ + COLOR

**LIST: \$1550 EA.**

**SELL: \$1000 EA.**

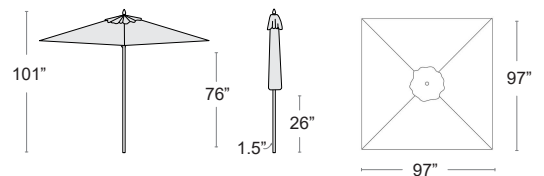



MADE IN CHINA



# Oasis - Cantilever 10' Square & 13' Octagon

Recasens Recacril 9 oz Marine Grade Solution Dyed Acrylic Fabric • Extruded aluminum mast & frame • Stainless steel hardware • Crank lift • Infinity tilt with 360 degree rotation • Protective Cover Included • Wind stabilizer kit included

LIST: \$5250 EA.    SELL: **\$3415 EA.**

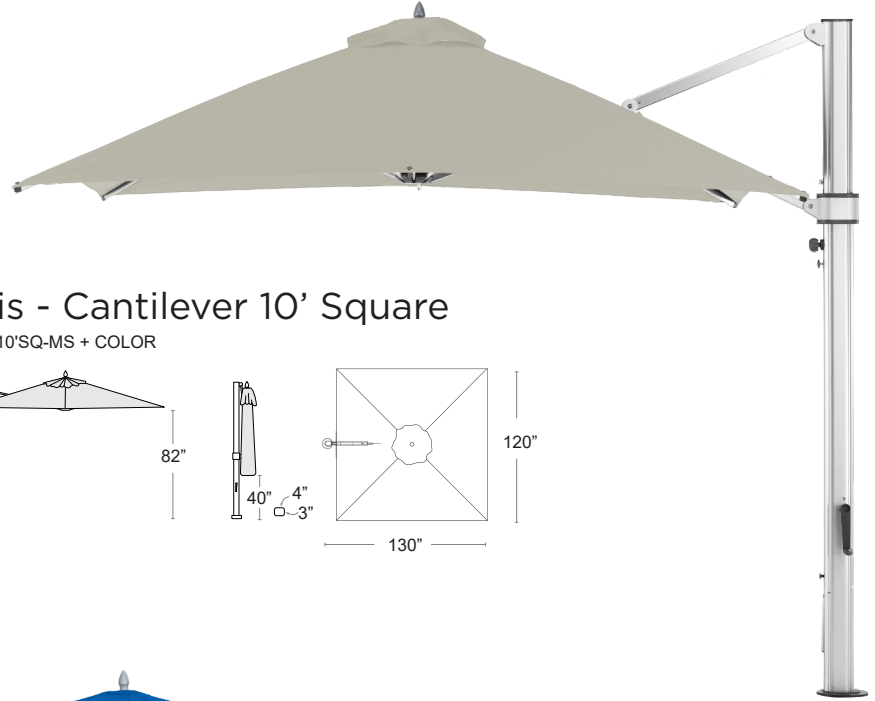

## Oasis - Cantilever 10' Square

883ECU-10'SQ-MS + COLOR

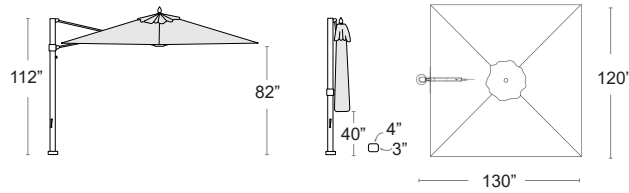

## Oasis - 13' Octagon Cantilever

880ECU-13OCT-MS + COLOR

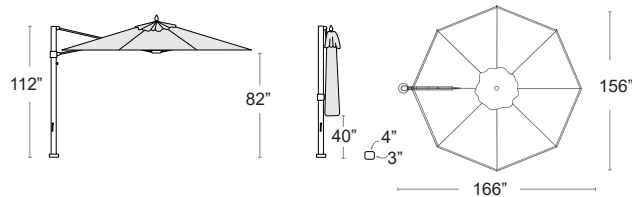

FRAME  
MATTE ALUMINUM



DARK GREY  
DK.GREY

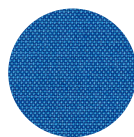

LAGOON  
LAGOON

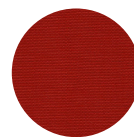

VERMILLION RED  
RED

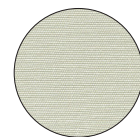

SEASHELL WHITE  
WHITE



## Oasis - V4 Cantilever 10' Square

Recasens Recacril 9 oz Marine Grade Solution Dyed Acrylic Fabric • Upgraded Aluminum Hub • New Frame Design with Heavier Ribs • Stainless steel hardware • Crank lift • Infinity tilt with 360 degree rotation • Universal Tilt Knob & Stop Pin • Wind stabilizer kit included • Protective Cover Included with Purchase

**LIST: \$7400 EA.    SELL: \$4810 EA.**

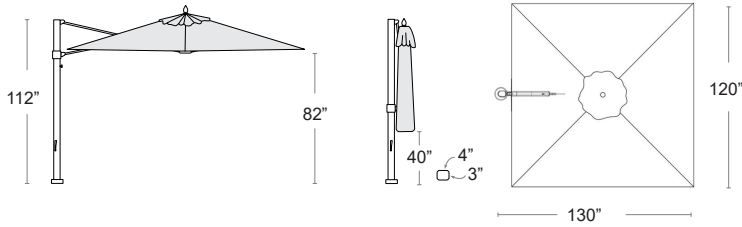

FRAME  
MATTE ALUMINUM



DARK GREY  
V4-883ECU-10'SQ-MS-DK.GREY

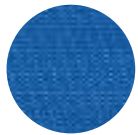

LAGOON  
V4-883ECU-10'SQ-MS-LAGOON



VERMILLION RED  
V4-883ECU-10'SQ-MS-RED



SEASHELL WHITE  
V4-883ECU-10'SQ-MS-WHITE



## Oasis - V4 Cantilever 10' x 13' Rectangle

Recasens Recacril 9 oz Marine Grade Solution Dyed Acrylic Fabric •  
 Upgraded Aluminum Hub • New Frame Design with Heavier Ribs •  
 Stainless steel hardware • Crank lift • Infinity tilt with 360 degree rotation  
 • Universal Tilt Knob & Stop Pin • Wind stabilizer kit included • Protective  
 Cover Included with Purchase

**LIST: \$8070 EA.     **SELL: \$5245 EA.****

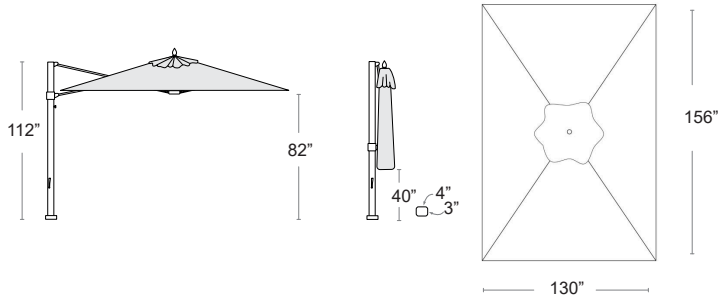

FRAME  
MATTE ALUMINUM



DARK GREY  
V4-898ECU-10X13-DK.GREY

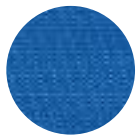

LAGOON  
V4-898ECU-10X13-LAGOON



VERMILLION RED  
V4-898ECU-10X13-RED



SEASHELL WHITE  
V4-898ECU-10X13-WHITE

SHADE



## Ocean Master MAX - Classic Cantilever

Tuuci Performance Fabric • Single wind vent • Polished aluminum frame • Offset pole • Market cut profile • High Wind Stabilizers • Crank telescoping lift system • Replaceable parts

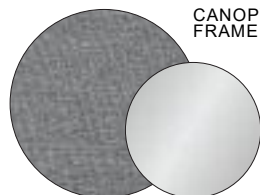
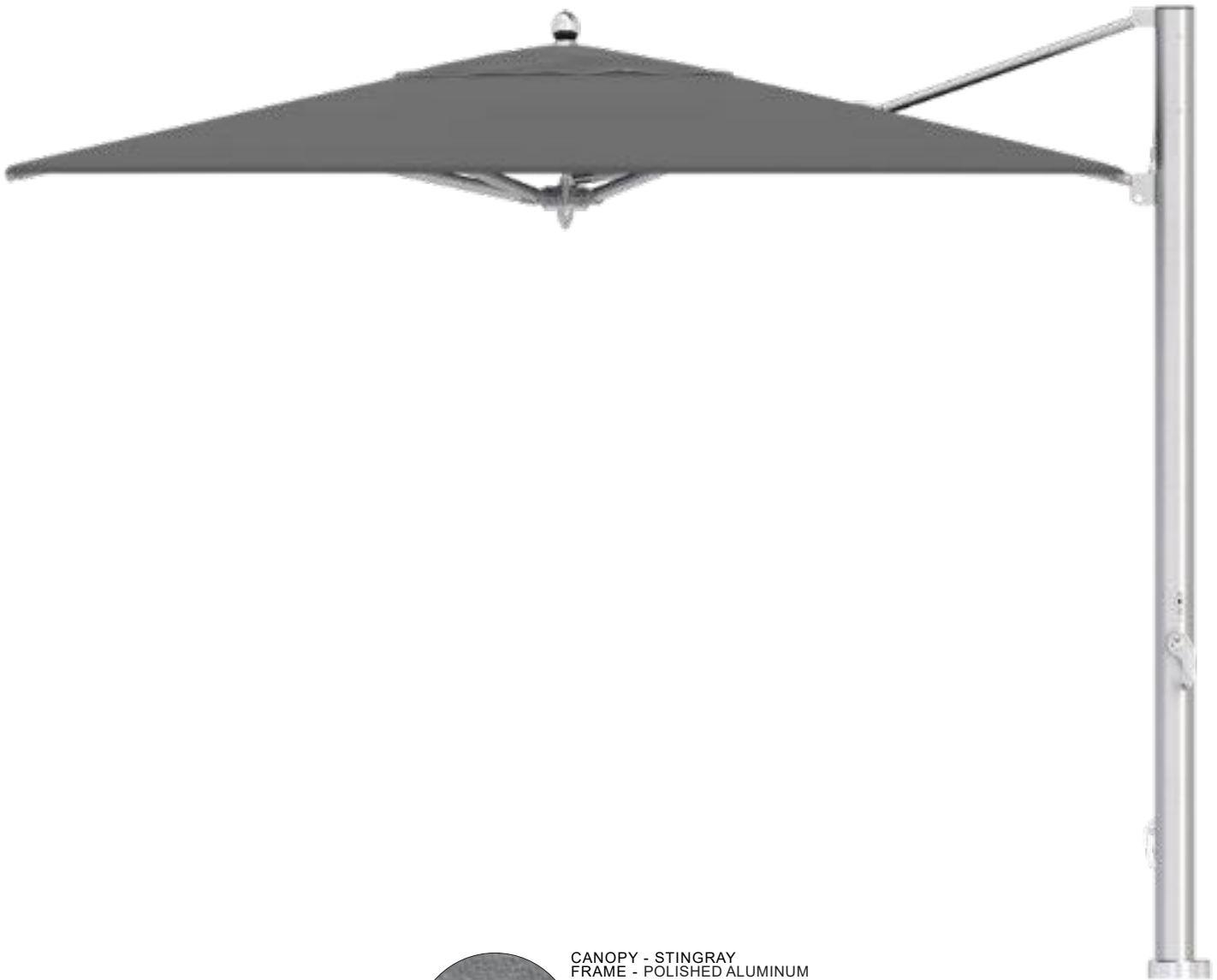

CANOPY - STINGRAY  
FRAME - POLISHED ALUMINUM

Details & Pricing next page



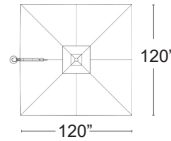
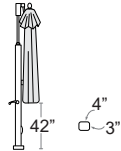
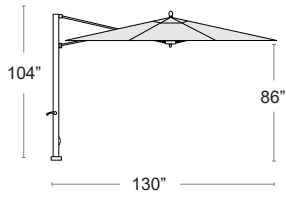

### 10' Square

CL-10.0SQ-STINGRAY

**LIST: \$13000 EA.**

**SELL: \$8450 EA.**

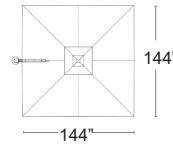
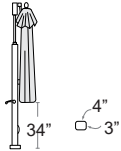
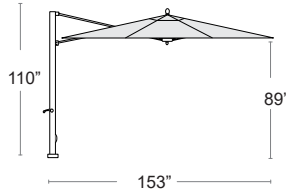

### 12' Square

CL-12.0SQ-STINGRAY

**LIST: \$16000 EA.**

**SELL: \$10400 EA.**

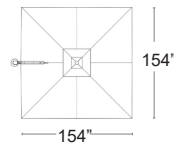
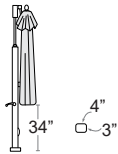
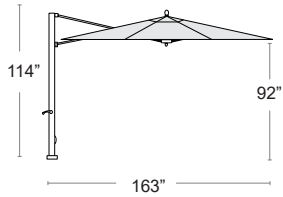

### 13' Square

CL-13.0SQ-STINGRAY

**LIST: \$18000 EA.**

**SELL: \$11700 EA.**

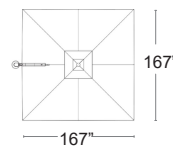
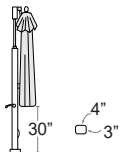
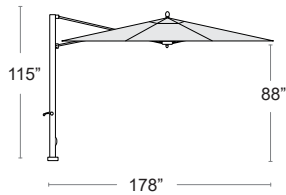

### 14' Square

CL-14.0SQ-STINGRAY

**LIST: \$19000 EA.**

**SELL: \$12350 EA.**

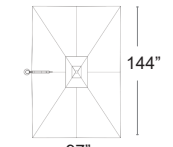
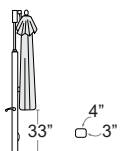
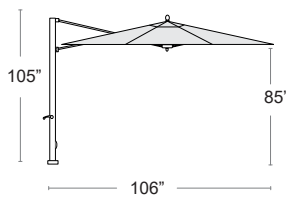

### 8' x 12' Rectangle

CL-8X12RECT-STINGRAY

**LIST: \$13000 EA.**

**SELL: \$8450 EA.**

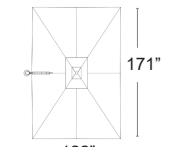
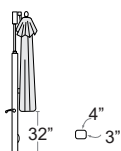
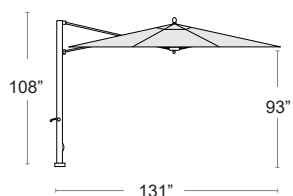

### 10' x 14' Rectangle

CL-10X14RECT-STINGRAY

**LIST: \$17000 EA.**

**SELL: \$11050 EA.**



## Bum Umbrella Bases

### Umbrella Locks

LIST: \$20 EA.

SELL: \$13 EA.

14" Cable Lock  
CABLE LOCK



Master Lock  
LOCK



### Oasis Coated Concrete Bases

Fits up to 1.5" diameter center pole umbrellas • Resin Coated • Concrete filled • 2 Locking Points



**MUST BE USED WITH A TABLE**

No Stem 16" Round 50 Lbs  
MATTE SILVER 50C-MS

LIST: \$180 EA.

SELL: \$120 EA.



18" Stem 20" Round 80 Lbs  
• Bottom ring bolttable  
MATTE SILVER  
OASIS-23-MS

LIST: \$280 EA.

SELL: \$185 EA.



Additional 35 Lb Ring  
MATTE SILVER  
OASIS-23-R

LIST: \$120 EA.

SELL: \$75 EA.

### Oasis Steel Base with Wheels

Fits up to 1.5" diameter center pole umbrellas • E-Plated Powder Coated • 16" stem • 2 locking points • 4 bolt down holes



24" Square Steel w/ wheels  
OASIS-75S-SM

LIST: \$590 EA.

SELL: \$385 EA.

### Aluminum Concrete

Fits up to 1.5" diameter center pole umbrellas • Aluminum E-Plated Powder Coated • Concrete filled • 18" Stem • 2 Locking Points



24" Round with Wheels - 100 lbs  
100A/18ST-MS

LIST: \$850 EA.

SELL: \$550 EA.

30" Round with Wheels - 150 lbs  
150A/18ST2-MS

LIST: \$1310 EA.

SELL: \$850 EA.

### Bum Galvanized Steel Bases

Fits up to 1.5" diameter center pole umbrellas • 1/2" Thick • 18" High Stem • 2 Locking Points



20" Square - 70 lbs  
20G-SQ/18ST-GS

LIST: \$970 EA.

SELL: \$630 EA.

24" Square - 100 lbs  
24G-SQ/18ST-GS

LIST: \$1100 EA.

SELL: \$715 EA.



24" Round - 70 lbs  
24G/18ST-GS

LIST: \$980 EA.

SELL: \$640 EA.

30" Round - 100 lbs  
30G/18ST-GS

LIST: \$1210 EA.

SELL: \$785 EA.



## Bum Oasis Cantilever Bases

### Oasis Deck Mount

To be used on existing concrete or wood surfaces • Use with Oasis Cantilever • 12.5" x .5" • 12 lbs

**LIST: \$600 EA.**

**SELL: \$390 EA.**

STAINLESS STEEL  
ECU-DP-SS



### Oasis In Ground Flush Mount

To be used on new cement only • Galvanized Steel • Use with Oasis Cantilever • 8" x 20" • 18 lbs

**LIST: \$370 EA.**

**SELL: \$240 EA.**

ECU-IG



### Oasis Galvanized Steel Box Frame with Wheels

480-MS

Slotted for 12 x Concrete Pavers (16" x 16" x 2")  
Not Included • Aluminum Cover Powder Coated  
Brushed Silver • 34" sq x 6.5" • 80 lbs empty

**LIST: \$1620 EA.**

**SELL: \$1055 EA.**



### Oasis Triple Stack with Wheels

OASIS-36G-SQx3+W

Galvanized steel plate • Silver Dacromet coated • Triple  
Stacked • Hardware included • 36" sq x 1.5" each • 600 lbs

**LIST: \$5080 EA.**

**SELL: \$3300 EA.**

\*The V4 Oasis Cantilevers require  
Quad Stacked • Hardware included •  
36" sq x 1.5" each • 800 lbs

**LIST: \$6773 EA.**

**SELL: \$4400 EA.**





## Tuuci Umbrella Bases



### In Ground Flush Mount

FLUSHMT

Stainless steel ground flush mount • Fits 1.5" thick center pole umbrellas • Aluminum extension pole • Mounting hardware included • 6 lbs

**LIST: \$600 EA.**

**SELL: \$390 EA.**



### Deck Mount

DECKMNT

Stainless steel • Fits 1.5" thick center pole umbrellas • 4 lbs

**LIST: \$250 EA.**

**SELL: \$165 EA.**



### Aluma Crete

Aluminum shell filled with concrete • E-Plated Powder Coat silver • Stainless steel security sleeve & hardware • Fits up to 1.5" thick center pole umbrellas • Lock hole available on request

20" Round - 65 lbs

ACF65

**LIST: \$480 EA.**

**SELL: \$315 EA.**

24" Round - 95 lbs

ACF95

**LIST: \$550 EA.**

**SELL: \$360 EA.**

28" Round - 150 lbs

ACF150

**LIST: \$720 EA.**

**SELL: \$470 EA.**



24" Round with Wheels - 95 lbs

ACF95W

**LIST: \$790 EA.**

**SELL: \$515 EA.**

28" Round with Wheels- 150 lbs

ACF150W

**LIST: \$960 EA.**

**SELL: \$625 EA.**



### G Bases

G base will fit all Tuuci umbrellas with a 1.5" thick center pole • Galvanized steel plates • Rounded corners • Each plate is 1/2" Thick • Deck mount & hardware included • Lock hole available on request

24" Round - 75 lbs

GV24RND

**LIST: \$700 EA.**

**SELL: \$455 EA.**



30" Round - 105 lbs

GV30RND

**LIST: \$910 EA.**

**SELL: \$590 EA.**

24" Square - 90 lbs

GV24SQ

**LIST: \$750 EA.**

**SELL: \$490 EA.**



30" Square - 140 lbs

GV30SQ

**LIST: \$1030 EA.**

**SELL: \$670 EA.**



### MAX On Ground Mount

MAXPLATE  
To be used on existing  
cement surfaces • 9"sq  
Stainless Steel • Mounting  
Hardware Included  
**LIST: \$1000 EA.**  
**SELL: \$650 EA.**



### MAX In Ground Mount

MAX IGSM  
To be used on new cement  
only • Stainless Steel  
**LIST: \$1000 EA.**  
**SELL: \$650 EA.**



### MAX Wood Deck Mount

MAX-MWDB  
**LIST: \$2000 EA.**  
**SELL: \$1300 EA.**



### MAX G Umbrella Bases

MAX G Base fits with MAX collection umbrellas • Galvanized steel plates • Rounded corners • Each single plate is 1/2" Thick • Stem comes with MAX umbrella, not base

MAX G Double Stack  
400 lbs  
GV36SQ X 2  
**LIST: \$3500 EA.**  
**SELL: \$2300 EA.**



MAX G Triple Stack  
600 lbs  
GV36SQ X 3  
**LIST: \$5000 EA.**  
**SELL: \$3250 EA.**



MAX G Quad Stack  
800 lbs  
GV36SQ X 4  
**LIST: \$6000 EA.**  
**SELL: \$3900 EA.**







# PLANTERS





## Artificial Bamboo Tree

Artificial foliage • UV Protected • Durable • Reusable

PERFECT FIT  
FOR  
NARDI'S SIPARIO  
PLANTERS  
- Page 210



### Bamboo Tree 60"

BAMBOO-60"

LIST: \$100 EA.

SELL: **\$65 EA.**

### Bamboo Tree 80"

BAMBOO-80"

LIST: \$160 EA.

SELL: **\$105 EA.**





## Hedge Planter Set

E-Coated Steel frame planter • Artificial foliage • UV Protected • Durable • Reusable

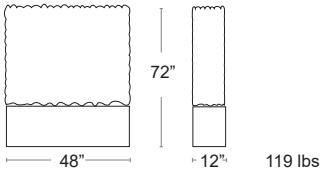

## Hedge Planter Set 4'

**LIST: \$1250 EA.**

**SELL: \$815 EA.**

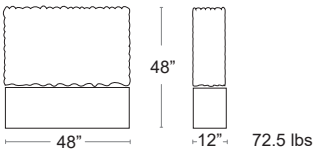

HEDGE 4'

## Hedge Planter Set 6'

**LIST: \$1760 EA.**

**SELL: \$1145 EA.**

## Wheels

**LIST: \$50 EA.**

**SELL: \$35 EA.**



HEDGE WHEELS 4PK



HEDGE 6'

# Sipario Self Watering Planter System

Modular partition with self watering plant system • Polypropylene resins • UV Protected • Award Winning



## Sipario 2

40394 + COLOR

**LIST: \$430 EA.**

**SELL: \$280 EA.**

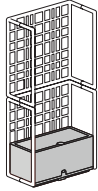
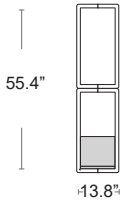
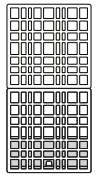

33 lbs



## Sipario 3

40395 + COLOR

**LIST: \$590 EA.**

**SELL: \$385 EA.**

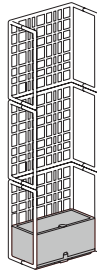
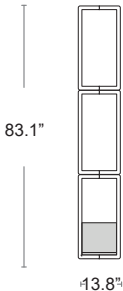
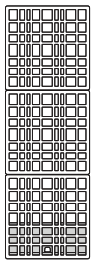

43 lbs

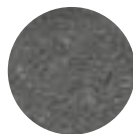

BASALTO  
25



CACTUS  
27



GESSO  
29



TERRA  
44

**SERRALUNGA**  
MADE IN ITALY

## Cubotti

Rotational molded • Double walled • UV protected • Recyclable • Durable

LIST: \$580 EA.

SELL: **\$375 EA.**

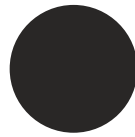
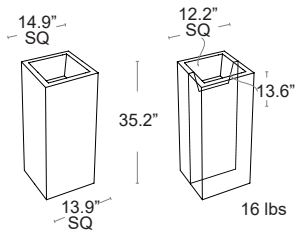

ANTRACITE  
335HIGH-ANT

**SERRALUNGA**  
MADE IN ITALY

## Vaso Rettangolare

Rotational molded • Double walled • UV protected • Recyclable • Durable

LIST: \$640 EA.

SELL: **\$415 EA.**

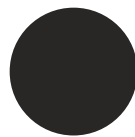
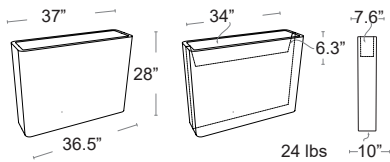

ANTRACITE  
722-ANT

Fence

Rotational molded • Single walled • UV protected • Recyclable • Durable

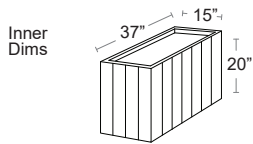
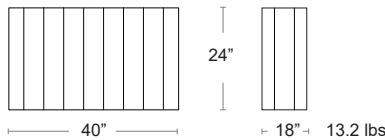
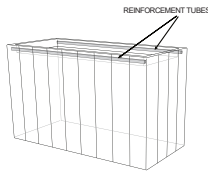
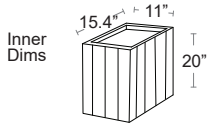
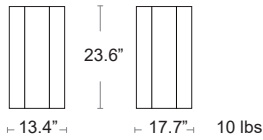

Fence Small

**LIST: \$390 EA.**  
**SELL: \$255 EA.**



715 SMALL-ANT

Fence Large

**LIST: \$1070 EA.**  
**SELL: \$695 EA.**



715-ANT



ANTRACITE

Neoclassic

Rotational molded • Single walled • UV protected • Recyclable • Durable

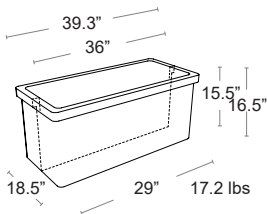

Neoclassic Cassetta

**LIST: \$500 EA.**  
**SELL: \$325 EA.**



NEOCLASSIC-710-ANT

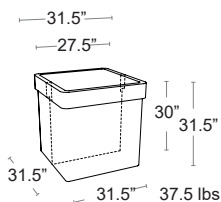

Neoclassic Quadro

**LIST: \$1160 EA.**  
**SELL: \$755 EA.**



NEOCLASSIC-788-ANT



ANTRACITE

## Torre

Rotational molded • Double walled • UV protected • Recyclable • Durable

**LIST: \$780 EA.     SELL: \$505 EA.**

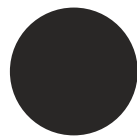
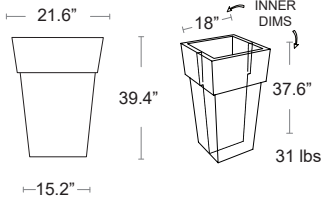

ANTRACITE  
TORRE 755-ANT

## Newpot Planters

Rotational molded • Double walled • UV protected • Recyclable • Durable

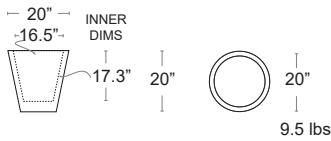

### Newpot 50

NEWPOT50 + COLOR

**LIST: \$410 EA.**  
**SELL: \$265 EA.**

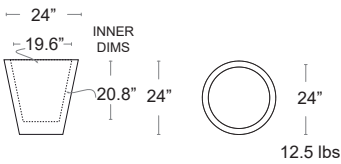

### Newpot 60

NEWPOT60 + COLOR

**LIST: \$540 EA.**  
**SELL: \$350 EA.**

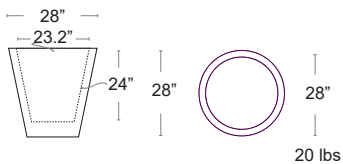

### Newpot 70

NEWPOT70 + COLOR

**LIST: \$780 EA.**  
**SELL: \$510 EA.**



ANTRACITE  
ANT

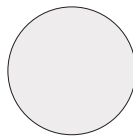

WHITE  
WH



**SERRALUNGA**  
MADE IN ITALY

## Cubotti Deep

Rotational molded • Double walled • UV protected • Recyclable • Durable



LIST: \$780 EA.

SELL: **\$510 EA.**

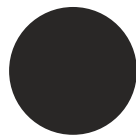
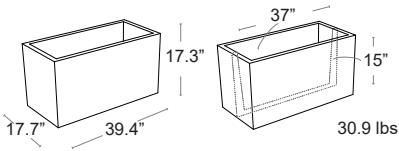

ANTRACITE  
310DEEP-ANT

### Lluna Planters

Rotational molded • Double walled • UV protected • Recyclable • Durable

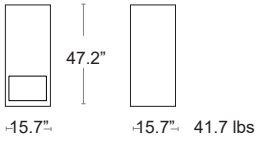

### Lluna Nova

**LIST: \$1200 EA.**  
**SELL: \$780 EA.**



LLUNA NOVA-ANT

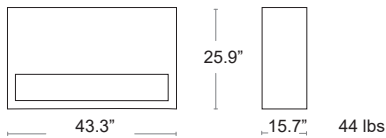

### Lluna 110

**LIST: \$1340 EA.**  
**SELL: \$870 EA.**



LLUNA 110-ANT

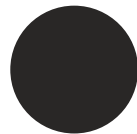

ANTRACITE

### Kabin Planters

Rotational molded • Double walled • UV protected • Recyclable • Durable

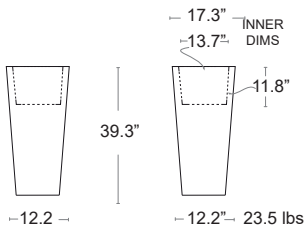

### Kabin Maxi

**LIST: \$830 EA.**  
**SELL: \$540 EA.**

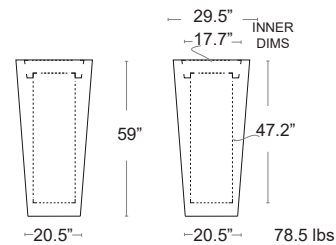

### Kabin Extra

**LIST: \$2270 EA.**  
**SELL: \$1475 EA.**



KABINMAXI-ANT

KABINEXTRA-ANT



ANTRACITE





**FLAME**





## Phantom Freestanding Heater

Electric infrared heater • 5,000 BTUs/1500W output  
• Standard 120V • High temperature shut off •  
Heating area: 144 sq ft. • 8' cord & storage  
compartment

**LIST: \$1000 EA.    SELL: \$650 EA.**

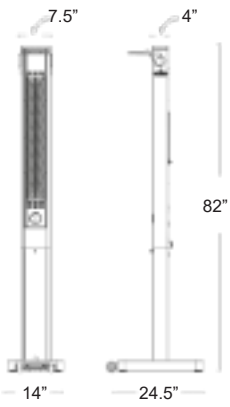

NEOFV80IH ELEC HEATER

COVER INCLUDED



## Nexus Flame Tables

Cast aluminum designed to look like concrete • 53,000 BTUs • Stainless steel burner with lava rock media • Cover included • Natural gas conversion kit sold separately

### Natural Gas Conversion Kit

SOLD SEPARATELY FOR ALL MODELS

S85004

**LIST: \$310 EA.     SELL: \$200 EA.**

### Nexus Flame Table 36"

**LIST: \$3080 EA.     SELL: \$2000 EA.**

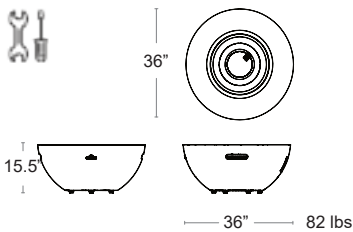

### Nexus Flame Table 56"

**LIST: \$4055 EA.     SELL: \$2635 EA.**

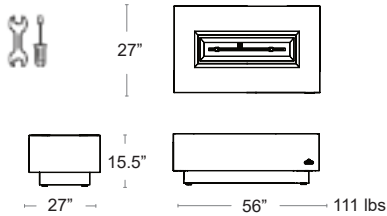

### Nexus Flame Table 72"

**LIST: \$5250 EA.     SELL: \$3400 EA.**

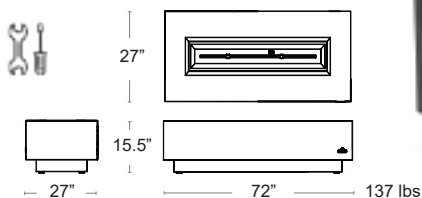

FLAME









# TERMS & CONDITIONS

## Product Dimensions/Information

All dimensions and weights shown are to be considered approximate as the majority of the products are manufactured in countries using the metric system; most measurements are converted from metric units. Bum Commercial Furniture (hereon referred to as "Bum" / "we") reserves the right to make improvements to information displayed in our catalogue as well as our website without prior notice.

Please note that all finishes on our marketing materials and website are approximate due to variation in color monitors and the processes of photography and printing.

## Assembly

Some products require assembly; please refer to the instructions included with item packaging or visit our website for information on assembly instructions. If instructions are not available, please contact [info@bumoutdoor.ca](mailto:info@bumoutdoor.ca)

## Availability

Bum orders items in this catalogue continuously based on historical values; depending on quantity, Quick Ship items should be readily available in stock, however, may have an extended lead time in case of current sell-out, or material shortages. We strive to keep substantial quantities of our bestsellers in stock at all times.

## Special Order

Bum has access to many items outside of our Quick Ship catalogue. Special order can be placed through Bum, however those items do have a significantly longer lead time, sometimes up to 22 months for items from EMU. Please note that all special order items require a special order form to be signed as well as a 25% deposit taken (in some cases). Once orders are placed, they cannot be cancelled. Customer is responsible for 100% payment of product cost if cancelled.

## Pricing

All prices published are LIST and SELL per single unit, and do not including shipping costs, taxes or installation. Due to frequent currency and raw material fluctuations, we reserve the right to change prices without notice.

All Bum Commercial Furniture dealers (brick and mortar and online) must not sell our products for less than the sell price listed in our current year Quick Ship catalogue and website.

## Quotes

Please contact your local Bum Commercial Furniture representative for quotes. For a local rep please contact [info@bumoutdoor.ca](mailto:info@bumoutdoor.ca). All quotations received from Bum Commercial Furniture or our sales representatives are valid for 30 days unless prolonged in writing.

## Sample Requests

Fill out the sample request form on our website <https://bumoutdoor.ca/sample-request/>. Bum has the right to deny sample requests if they see fit.

## Placing of Orders

All orders are to be sent to [orders@bumoutdoor.ca](mailto:orders@bumoutdoor.ca) with your sales representative on CC (if applicable). Orders must be sent in the form of a formal purchase order. These orders are subject to acceptance by Bum. All orders must contain the following information:

Bill to + contact name + phone number

Ship to + contact name + phone number

Proper product codes, colors + quantity required

Requested ship date or required on site date and shipping requirements (i.e. call before, appointment delivery, tailgate delivery) and/or state that customer is picking up (Bum does not guarantee delivery by those dates but will do their best to accommodate)

Purchase order number or code

## Acknowledgement

Order acceptance will be made in the form of a sales order confirmation. This confirmation will include an estimated ship date based on dates the customer has provided. If they are not provided, the "date required" will be noted as the date of the sales order entry. The sales order will also include lead times/estimated warehouse arrivals (EWA) listed on each line item if applicable.

Sales Order Confirmations must be reviewed for corrections immediately upon receipt. There will be a link provided in which the customer must click and "approve" the order. Without that being done, the order is not yet confirmed and valid. Bum will not be held responsible for any errors or missing information on sales order confirmations. All orders will ship ASAP unless otherwise noted on the purchase order. Please note: if an order is split shipped, backorder shipping charges will apply.

Accepting the order confirmation online is the customers' acceptance of all these terms.

Once shipped, invoices are sent via email with tracking information on the day of the shipment.

## Backorders

Standard shipping charges apply to all backorders. All backorders will ship once the product becomes available.

## Payments and Credit

Payment Methods Accepted: EFT / ACH / Company Checks / E-transfers / Credit Cards (fees may apply).

Returned checks are subject to a \$100 fee NSF fee.

## Required Deposits

Each of the following requires a 25% non-refundable deposit and/or a special order form being signed:

Special Order Items

Direct Containers

Clearance Items

In the case where terms have been established with Bum, only the form is required (aside from clearance items).

## Deductions

No deductions may be made from remittance without email authorization from Bum Commercial Furniture.

## Collections

In the event of delinquency, the customer shall be responsible for all collection costs, including attorney's fees incurred by Bum Commercial Furniture.

## Refunds

Should a refund be required due to overpayment, this may only be processed after the completion of the related purchase order. The completion of the purchase order is when the order is shipped and invoiced.

## Returns

Special order items, parts, clearance, and cushions are not returnable and non-refundable.

QuickShip items may be returned within 30 days from the invoice date with an RMA (return merchant authorization). Items must be received in their original condition, in original boxes including all original interior packaging, and palletized for a full refund (or brought directly back to the warehouse for a full refund minus a 25% restocking fee.

# TERMS & CONDITIONS

## Re-Stocking Fee

A minimum of 25% restocking fee will be charged for the return of Quick Ship items in their original condition.

Credit for returns will only be issued after receipt and inspection of returned merchandise. Damaged returns are subject to additional charges incurred to restore goods to their original condition or the customer may reclaim the items if the determined credit amount is insufficient.

No return of merchandise will be accepted to our distribution centre without our email consent and RMA number, which includes the appropriate shipping instructions.

Unauthorized returns will be refused and/or returned freight collect.

RMA # is only valid for 15 days from the issue date. A copy of the RMA must accompany the returned merchandise, and the RMA # must appear on each carton returned.

Any additional cartons needed for return will be charged to your account. No credit will be issued for goods without our email consent.

## Estimated Ship Date

All estimated ship dates are approximate only. Bum cannot be held responsible for financial damage due to late shipping. All orders are subject to delay or failure of delivery due to problem with source of supply, transportation, war, riots, fire, accidents, compliance with government regulations, strikes, Acts of God, or other causes beyond our control.

## Shipping

Shipping and routing instructions are required for each third-party shipment. If no such instructions are received, we have the right to ship by carrier of our choice. If billing a third-party, the payer's discount program will take precedence; please consult your carrier for a freight quote.

Customer pickup is available from our distribution centre, a pickup appointment must be booked before arrival. The link to do that is <https://bumoutdoor.ca/pickup/>. If customers come to the warehouse without an appointment they will be turned away, missed pickups may be subject to additional fees.

## Refusals

If a shipment is refused, re-consigned, re-delivered, storage or additional services are rendered that were not mentioned at the time of the freight quote/shipment, the customer is responsible for all additional charges incurred, and applicable re-stocking fees.

## Freight Quotes

Freight quotes provided by Bum Commercial Furniture must be sent alongside any orders. If a freight estimate # is not received, freight will be requested. Please ensure that when requesting a freight quote you send it to [freight@bumoutdoor.ca](mailto:freight@bumoutdoor.ca) with the appropriate information required and/or fill out the form on our website <https://bumoutdoor.ca/freight-quote/>. Freight quotes will be done as quickly as possible, please try to keep the number of revisions of freight requests to a minimum so we can serve as many customers as we can in a timely manner.

## Stock Hold/Storage Fees

Product cannot be reserved or held for over 30 days unless a 25% deposit is received. Orders will be held for up to 6 months. After 6 months, a storage fee of \$25+tax will be charged per pallet worth of product. This storage amount will be added to the sales order/invoice and must be paid in full before shipping/pickup or by the payment date noted on your invoice.

## Third-Party Reselling

Bum Commercial Furniture does not authorize third party reselling (the practice of an authorized Bum Dealer selling Bum to another retailer). Authorized Bum Dealers must be clearly identified and fulfil the order.

## Claims and Damages

Bum Commercial Furniture carefully packages its products and inspects them thoroughly before they leave the warehouse. Photos are also taken. It is the duty of the receiving party/consignee to inspect and receive all merchandise immediately upon arrival for any visual and/or concealed damage. Effective immediately: all freight deliveries from Bum Commercial Furniture are required to be inspected by the receiving party/consignee before the carrier leaves their facility. A signature and note of any potential damage must be clearly documented in detail on the Bill of Lading.

If freight damage is discovered after the carrier has left the facility and has not been documented on the Bill of Lading, those damages and/or replacements will be the responsibility of the receiving party/consignee. The product will not be eligible for refund or replacement by Bum Commercial Furniture.

Products with freight damage from all Third-Party and Collect shipments (including pickups) are not eligible for replacement by Bum Commercial Furniture. Customers must contact their carrier directly.

## Freight Claims and Damages

### VIA 3rd Party

If a specific carrier was requested on the purchase order, the customer takes full responsibility for all freight issues, including contacting the carrier, damages, losses, and additional freight charges, and claims.

### VIA Carrier

Before accepting and signing the merchandise from the carrier, inspect all cartons for visible or concealed damage and clearly note any loss or damage on the delivery receipt/Bill of Lading. If there is loss or damage, make an immediate claim with the delivery carrier. In the event of concealed damage, save all cartons and packing materials and notify the freight carrier and Bum Commercial Furniture immediately for inspection. Missing items/parts/hardware claims against us will be considered only if filed with us via our website <https://bumoutdoor.ca/warranty/> within 3 days of the delivery date. Failure to make such a claim shall constitute acceptance of the merchandise and waived of any defects, errors, or shortages. Bum Commercial Furniture is not responsible for damage or loss incurred in transit. All furniture is shipped at the purchaser's own risk after it has been inspected and securely packaged at the distribution centre. It is accepted as such by the freight carrier.

## General Maintenance

As with any piece of equipment, proper and periodic maintenance is necessary to ensure the longevity of the product and customer satisfaction. To ensure you get the most out of your investment, please follow our recommended maintenance and care instructions.

We recommend that the products be examined every 30 days. Items requiring adjustments, showing any sign of structural failure, missing hardware, or showing any cracks at the welds should be taken out of service immediately until repaired.

Loose screws should be tightened as required and missing or worn-out foot caps must be replaced. To obtain replacement parts, please contact your local sales representative and/or [info@bumoutdoor.ca](mailto:info@bumoutdoor.ca).

Furniture should be handled with care. When chairs are stacked, the stack should not be dragged. Stackable chairs should not be dropped or slammed down when being unstacked. People should not rock back or stand on the seats.

For storage, all furniture should be stored neatly, stacked to the suggested height, and packed in a clean and dry area. Tables should not be flipped and stacked. Any standing water needs to be removed to avoid damage to the finish. Cushions that are stored for longer periods of time should be stored in a well ventilated area.

Note: warranty may be voided if proper maintenance or care is not followed. Proof of care and maintenance is required with claims being made.

## Warranty

Bum Commercial Furniture has a 3 year limited warranty on all products. The limited warranty does not apply to damage resulting from accident, alteration, misuse, tampering, negligence, abuse or normal wear and tear. All items must be properly assembled and taken care of as per instructions. Upkeep of product (i.e. replacing chair feet) is the responsibility of the customer.

Warranty is only valid if all parts that can wear (i.e. foot caps) are replaced annually. Parts must be purchased within one month of replacement time and proper maintenance must be followed. Product failure caused by lack of reasonable and necessary care and maintenance is not covered under warranty.

# BUM OUTDOOR FURNITURE

1-2





**IN STOCK READY TO SHIP**

**406 - 950 COLLIER BOULEVARD  
MARCO ISLAND, FL 34145**

**📞 1-855-337-2995    ✉ info@bumoutdoor.com**

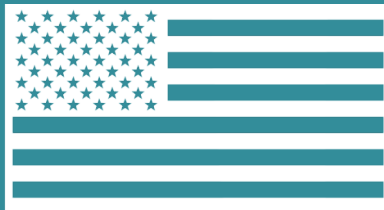

**WWW.BUMOUTDOOR.COM**